

Instruction Manual

FLUID COUPLINGS

Coupling Styles:
KCP: 11-24
CKCP: 12-24
KCM: 7-34
CKCM: 12-34

Sheave Style:
KSD: 7-24

These instructions must be read thoroughly before installation or operation.

DESCRIPTION

A fluid coupling is a hydrokinetic transmission unit comprised of three main elements:

1. Driving impeller (pump) mounted on the input shaft.
2. Driven impeller (turbine) mounted on the output shaft.
3. Cover, flanged to the output impeller, with an oil-tight seal.

The first two elements can work both as pump and/or turbine. The impellers perform like a centrifugal pump and a hydraulic turbine. With an input drive to the pump (e.g., electric motor or Diesel engine) kinetic energy is imparted to the oil in the coupling. The oil moves by centrifugal force across the blades of the turbine towards the outside of the coupling. This absorbs the kinetic energy and develops a torque which is always equal to input torque thus causing rotation of the output shaft. The wear is practically zero since there are no mechanical connections. Figure 1 shows an example of a fluid coupling and its major components:

1. Input (motor shaft)
2. Output (driven shaft)
3. Fluid Coupling Unit
4. PARA-FLEX® PH Style Coupling

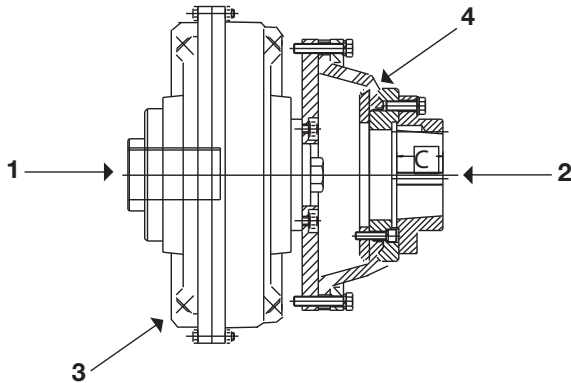

Figure 1 - KCP Fluid Coupling

WARNING: Because of the possible danger to person(s) or property from accidents which may result from the improper use of products, it is important that correct procedures be followed. Products must be used in accordance with the engineering information specified in the catalog. Proper installation, maintenance and operation procedures must be observed. The instructions in the instruction manuals must be followed. Inspections should be made as necessary to assure safe operation under prevailing conditions. Proper guards and other suitable safety devices or procedures, as may be desirable, or as may be specified in safety codes should be provided, and are neither provided by Baldor Electric Company, nor are the responsibility of Baldor Electric Company. This unit and its associated equipment must be installed, adjusted and maintained by qualified personnel who are familiar with the construction and operation of all equipment in the system and the potential hazards involved. When risks to persons or property may be involved, a holding device must be an integral part of the driven equipment beyond the speed reducer output shaft.

INSTALLATION / DISASSEMBLY

Model KCP/CKCP:

This coupling contains two sections consisting of a fluid coupling circuit (the CKCP contains a delay-fill chamber) and a PARA-FLEX® coupling consisting of a PARA-FLEX PH high speed element and PS assembly with TAPER-LOCK® bushing. Install in the following sequence:

1. Set the Between Shaft Ends (B.S.E.) Dimension for the Driver and Driven Equipment (Table 1).

Table 1

Size	Fluid Cplg. Bore Size	BSE	
		KCP	CKCP
11	1.625	6.26	-
	1.875	5.64	
12	1.625	6.21	8.87
	1.875	5.59	8.25
13	1.875	7.46	9.82
	2.125	6.83	9.19
15	2.375	6.21	8.57
	2.125	9.86	12.54
17	2.375	9.24	11.92
	2.875	7.86	10.54
19	2.375	10.11	13.26
	2.875	8.73	11.88
21	3.375	8.11	11.26
	2.375	10.11	13.26
24	2.875	8.73	11.88
	3.375	8.11	11.26
24	2.375	11.79	15.73
	3.375	10.54	14.48
24	2.875	11.79	15.73
	3.875	10.29	14.23

NOTE: It is necessary to mark the BSE setting on the base where the motor is mounted. The fluid coupling unit is larger than necessary between shaft ends and will need to be installed after marking the setting and then moving the motor back to allow for adequate room.



To install the KCP and CKCP Fluid Coupling, the motor shaft may need to be threaded. Values are given in Table 2.

Table 2

Size	Fluid Cplg. Bore Size	Thread for installation	Housing Thread for Dismounting	KCP minimum rod length	CKCP minimum rod length	KSD minimum rod length	Mtr. Shaft Hole Depth	Mtr. Shaft Thread Depth
11	1.625 1.875	1/2-13 UNC	3/4-10 UNC	12	-	-	2.25	1.5
12	1.625 1.875			12	14	-	2.25	1.5
13	1.875 2.125 2.375		3/4-10 UNC	7/8-9 UNC	12	15	-	2.25
15	2.125 2.375 2.875	15			17	20	2.25	1.75
17	2.375 2.875 3.375	7/8-9 UNC	1-1/4-7 UNC	15	18	23	2.5	2
19	2.375 2.875 3.375			15	18	23	2.5	2
21	2.375 3.375			17	21	25	2.5	2
24	2.875 3.375 3.875			17	21	27	2.5	2

NOTES: FOR SIZES 11-13, IT IS NOT NECESSARY TO THREAD THE SHAFT.

If drilling and tapping the motor shaft, install threaded rod onto motor shaft, install motor shaft key, and follow mounting procedure as given in Step 2.

2. Install Fluid Coupling:

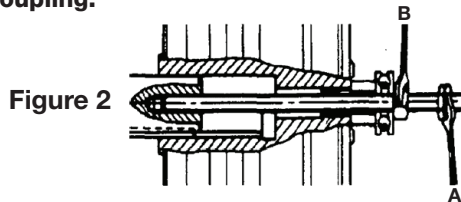

Using the threaded bar as shown on Fig. 1, and using two wrenches (hold wrench "A" and turn wrench "B" to draw the coupling on to the motor shaft). For a good mounting, make sure shafts are clean and without burrs, and lubricate the mating surfaces with oil or antiseizing grease. Note: In case of hot mounting (not recommended), do not reach a temperature above 195°F, or higher, which causes irreparable damages to oil seals. Tighten wrench "B" until the motor shaft end completely slides onto coupling bore. Tighten the two setscrews on fluid coupling to lock it in place. Remove the threaded rod.

Important Notice: Always mount the KCP/CKCP coupling so that the fluid coupling is mounted on the input (motor) side.

3. Remove Fluid Coupling:

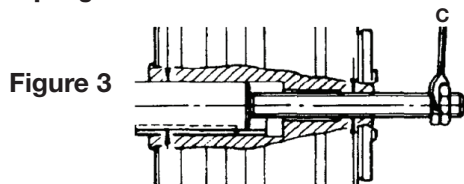

Back off locking screws. Engage the dismounting threaded bar "C" (this is different from mounting threaded bar) onto the back of the fluid coupling (Figure 3). Continue with threading of the rod against the motor shaft. This will cause the fluid coupling body to slide off the motor shaft.

For KSD models provided with collet (sizes 7 through 13) proceed as follows:

1. Remove hex head capscrew which retains the collet.
2. Tap the fluid coupling body with a mallet. The fluid coupling should break free from the motor shaft.
3. Remove input shaft and coupling assembly with sheave from motor shaft adapter. Remove sheave from sheave hub.

4. Assemble PARA-FLEX® Coupling to Fluid Coupling Unit and Driven Equipment

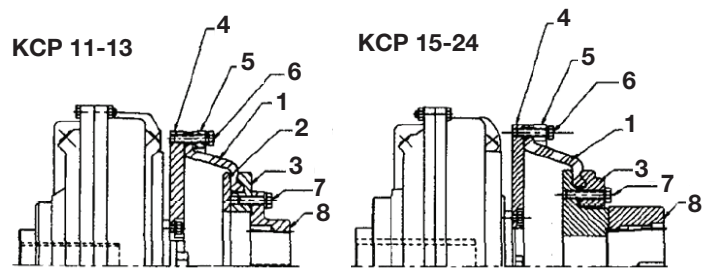

- 1 FLEXIBLE ELEMENT
- 2 INTERNAL CLAMP RING
- 3 EXTERNAL CLAMP RING
- 4 FLUID COUPLING ADAPTER PLATE
- 5 BOLT RING
- 6 DISC ASSEMBLY SCREWS
- 7 CLAMP RING SCREWS
- 8 SPACER HUB

Figure 4

Connect adapter plate (#4) to fluid coupling unit. For KCP/CKCP sizes 11 and 12, torque nuts attaching the adapter plate to 216 lb-in. For sizes 13, 15, 17, and 19, torque to 425 lb-in. For sizes 21 and 24, torque to 1,175 lb-in.

Before installing the flexible element, slip bolt ring over flange and rest it on the shaft. Remove clamp ring screws and internal clamp ring. Place internal clamp ring inside the element and reassemble to flange seating the bead of the element on the flange. Tighten clamp ring screws alternately and evenly and torque to values shown in column "A" in Table 3. On coupling sizes 15 through 24, remove external clamp ring and rest it on shaft. Attach the spacer hub to the clamp ring (external clamp ring for sizes 11-13 and internal clamp ring for sizes 15-24). Torque to values in Table 3, column "D". Install TAPER-LOCK bushing into flange. Turn element on flange and reassemble clamp ring and screws.

Place bolt ring and screws in position. Tighten down screws through the bolt ring and element through to the fluid coupling adapter plate. Tighten screws alternately and evenly and torque to values shown in Table 3, column "B".

Table 3

Fluid Coupling Size		Coupling Size	Flange Assembly Size	Wrench Torque (lb-in.)		(lb-in.) B	(lb-in.) D	E
				A				
				Steel Flanges	Iron Flanges			
11	KCP/CKCP	PH 96	PX 80	290	290	300	300	0.025
12	KCP/CKCP	PH 116	PX 100	480	480	360	300	0.030
13	KCP/CKCP	PH 131	PX 110	480	480	420	300	0.035
15, 17, 19	KCP/CKCP	PH 172	PX 140	1150	1080	600	720	0.045
21, 24	KCP/CKCP	PH 192	PX 160	1150	2160	780	1296	0.050

5. Check Shaft Alignment of High Speed PARAFLEX® Coupling

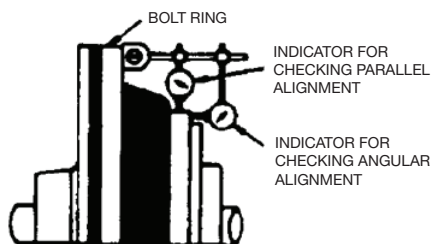

Figure 5

Although shafts may be perfectly aligned at installation, some parallel and angular misalignment usually develops in usage because of shifting of the driving and driven units. Check both parallel and angular alignments by mounting indicators near the O.D. of the flange as shown in the graphic above and rotate the coupling through 360°. For a good installation, neither indicator reading should exceed the value shown in Table 3, column "E". Both alignments should be rechecked after any repositioning.

INSTALLATION:

Model KSD:

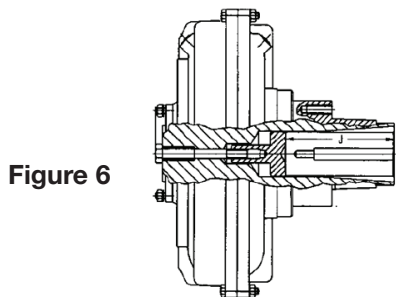

Figure 6

This fluid coupling is to be installed on the end of a drive shaft with a sheave mounted on the fluid coupling.

Sizes 7 through 13 are provided with an adapter collet. Install in the following sequence:

1. Install key flush with end of drive shaft.
2. Install sheave to fluid coupling hub, torque bushing capscrews properly (see recommended bolt torques listed).
3. Install coupling assembly on drive shaft, (it may be necessary to free the slotted adapter by pushing on loosened center capscrew). Make sure slotted adapter does not ride up on any radius or shoulder on the drive shaft. Note: Shaft must protrude into slotted adapter 2.50 inches minimum.
4. Torque retaining collet capscrew.

CAUTION: The fluid coupling is installed on the end of a shaft and it is essential that a guard be provided.

Sizes 15 through 24 are provided without collet. Install in the following sequence:

1. To install KSD or CKSD fluid coupling, the motor shaft may need to be threaded. Values are given in Table 2.
2. Fit fluid coupling on motor shaft by using a threaded bar as shown on Figure 2 and using two wrenches (hold wrench "A" and turn wrench "B" to draw the coupling on the motor shaft).
3. After fitting, lock it down using the fixing bolt. The fixing bolt thread must be the same as the thread for installation as given in Table 2.

Table 4 - Recommended Tightening Torque for Fixing Bolt

Size	Torque (Max.)
¾-10 UNC	3000 lb-in.
7/8-9 UNC	4200 lb-in.

Table 5 - Recommended Tightening Torque for Bolt-On Sheaves

Qty	Size	Torque
12	M10	360 lb-in.
8	M14	720 lb-in.

For good mounting, make sure shafts are clean and without burrs, and lubricate the mating surfaces with oil or antiseizing grease.

For REMOVAL: Refer to section 3 on page 2.

Model KCM, CKCM:

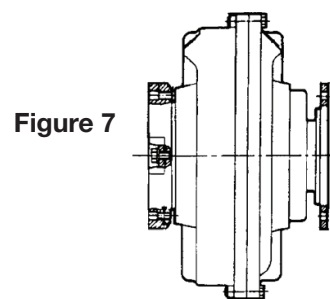

Figure 7

This coupling is a complete unit and is to be installed between two halves of a double engagement gear tooth flexible coupling. The gear coupling halves need to have a shrouded bolt design, not the exposed bolt version. Install in the following sequence:

1. Set between shaft spacing for driver and driven equipment per chart below.
2. Install gear coupling half to each shaft.
3. Align shafts to within 0.030 total indicator reading.
4. Install fluid coupling.
5. Torque coupling bolts to recommended installation torque as shown in gear coupling instruction manual.

Table 6 - BSE Spacing for KCM/CKCM Couplings

Size	KCM Centre Distance	CKCM Center Distance	Gear Coupling Size
7	5.63	—	201
8	5.83	—	201
9	7.09	—	201½
11	7.44	—	201½
12	7.91	10.55	201½
13	8.31	11.28	201½
15	10.04	13.15	202½
17	10.04	13.27	202½
19	10.04	13.27	202½
21	12.78	16.80	202½
24	12.78	16.80	202½
27	14.70	20.96	203½
29	15.84	22.10	203½
34	18.79	25.21	204

NOTE: The input side flange on the fluid coupling has clearance holes for the gear coupling bolts and the output side flange is threaded. The fluid coupling unit is supplied with two accessory kits. These kits include bolts, nuts, lockwashers, and gaskets.

FILLING INSTRUCTIONS

Series KCP, KSD, KCM:

Fluid couplings are not filled at the factory and thus a correct filling procedure is necessary:

1. With the fluid coupling mounted in a horizontal plane, turn the coupling so the X mark which is cast into the housing is at the top (maximum filling) which will ensure the filler/level plug item 13, is in the correct angular position as shown in Figure 8.
2. Fill with oil until it overflows out of the filler hole. During filling, rock the coupling gently on its axis to ensure all excess air is vented from the circuit. Table 7 shows various oil quantities for different fillings. The filling procedure for these intermediate fills is the same as outlined above, in each case the number must be at the top of the unit.
3. To ensure no oil leaks from coupling during its operation, use thread sealant on filler plug thread.
4. The different filling X-1-2-3-4 can be selected at the users discretion to obtain a better performance from the coupling. With X fill (maximum), the fluid coupling will operate with minimal slip and maximum efficiency. The ratio starting torque/nominal torque will be at maximum. By decreasing the coupling's oil filling (1-2-3-4), the contrary occurs.
5. High values of slip decrease the unit's efficiency and will cause the oil to overheat.
6. Fluid recommendations are indicated in Table 9.
7. For vertical mounted applications, fills are indicated in Table 7.

Series CKCP, CKSD, CKCM:

Fluid coupling CK series (with delayed fill chamber) is used to limit the starting torque/nominal torque ratio to 1.4. The starting torque limitation can be obtained by reducing the oil quantity in the working circuit (filling 2-3-4) without increasing the slip value at rated speed. For each given size, see Table 7 or 8 for proper filling position.

After filling the coupling, start the motor and check to make sure the fluid coupling operates properly. After approximately 100 hours, stop the motor and check the alignment and tightness of the screws.

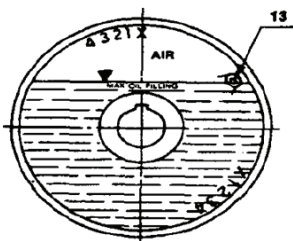

Figure 8

Table 7 - K... Series Oil Qty. U.S. Gal.

K...	X	1	2	3	4
6	.132	.126	.120	.112	.103
7	.243	.227	.211	.192	.171
8	.338	.314	.290	.264	.237
9	.515	.480	.446	.409	.369
11	.727	.673	.620	.554	.488
12	1.083	1.023	.944	.858	.766
13	1.374	1.281	1.175	1.070	.951
15	2.020	1.889	1.743	1.585	1.426
17	3.090	2.879	2.642	2.404	2.166
19	3.750	3.513	3.249	2.959	2.642
21	5.020	4.702	4.332	3.963	3.566
24	7.500	7.001	6.499	5.970	5.416
27	11.090	10.300	9.511	8.850	8.322
29	14.533	13.47	12.417	11.624	10.964

Table 8 - CK ... Series
Oil Qty. U.S. Gal.

CK ...	2	3	4
11	.885	.805	.726
12	1.268	1.109	.951
13	1.532	1.373	1.241
15	2.272	2.034	1.690
17	3.593	3.381	3.091
19	4.306	4.015	3.698
21	6.076	5.627	5.099
24	8.243	7.556	6.869
27	13.21	12.28	11.36
29	16.64	15.58	14.26

For fluids (F) with specific gravity (S.G.)
Other than fluid (G) with S.G. .88 at 60°F

$$\text{HP. fluid (F)} = \text{H.P. fluid (G)} \times \frac{\text{S.G. fluid (F)}}{\text{S.G. fluid (G)}}$$

Table 9 - Fluid Recommendation

Coupling Operating Temperature	
Above 160°F	Below 160°F
SAE 10 W Non-Detergent	SAE 5 W Non-Detergent

OPERATION AND MAINTENANCE

1. Start motor several times to check the coupling performance. Maximum temperature should not exceed 195°F. For higher temperatures, contact Baldor Electric, Dodge Engineering, Greenville, SC.

High oil operating temperature can be caused by:

- a) Insufficient oil filling.
 - b) Absorbed power is higher than the motor rated power.
 - c) High ambient temperature.
 - d) Too frequent starts.
 - e) Long starting time.
 - f) Inadequate air ventilation to allow cooling of the coupling. If coupling is operating in a restricted space, adequate ventilation apertures should be provided.
2. After the first 20 days of operation, check the filling (this must be carried out with cold oil). Also, check the motor and driven machine's fixing bolt.
 3. Coupling is supplied with fusible plug at 290°F (250°F, 350°F, or 390°F upon request). It is suggested that these alternative fusible plugs should be considered for belt conveyors, crushers, mills, mixers, etc. where continual overload conditions can occur. If the fusible plug blows at regular intervals in normal service, then re-check a) through f) above.
 4. Oil should be replaced after 4,000 hours operation.

BALDOR®

World Headquarters

P.O. Box 2400, Fort Smith, AR 72902-2400 U.S.A., Ph: (1) 479.646.4711, Fax (1) 479.648.5792, International Fax (1) 479.648.5895

Dodge Product Support

6040 Ponders Court, Greenville, SC 29615-4617 U.S.A., Ph: (1) 864.297.4800, Fax: (1) 864.281.2433



www.baldor.com