

DODGE Load Indicated Take-Up Frame Instruction Manual

These instructions must be read thoroughly before installing or operating this product.

WARNING: To ensure the drive is not unexpectedly started, turn off, lock out and tag power source before proceeding. Failure to observe thisprecautions could result in bodily injury.

1. The take-up frame will arrive in two pieces, the frame and screw assembly. (WSTU housing and bearing are sold separately.)

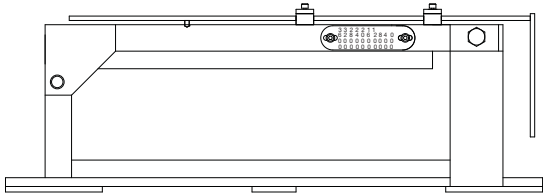

2. Stand the frame up on feet and remove the hex bolt and hex nut from the end.
3. Remove Upper Guide located to the left of the Load Indicator Plate by removing the bolts holding it in place.

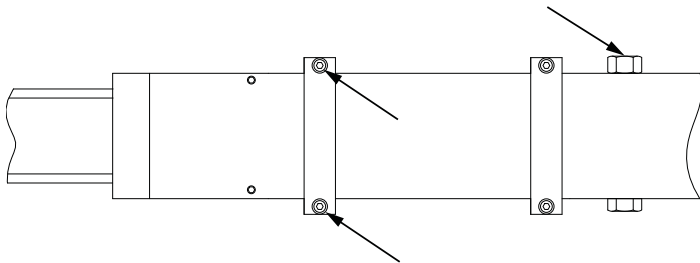

WARNING Because of the possible Danger to persons or property from accidents which may result from the improper use of products, it is important that correct procedures be followed: Products must be used in accordance with the engineering information specified in the catalog. Proper installation, maintenance and operational procedures must be observed. The instructions in the instruction manual must be followed. Inspections should be made as necessary to assure safe operation under prevailing conditions. Proper guards and other suitable safety devices or procedures as may be desirable or as may be specified in safety codes should be provided, and are neither provided by Baldor Electric Company nor are the responsibility of Baldor Electric Company. This unit and its associated equipment must be installed, adjusted and maintained by qualified personnel who are familiar with the construction and operation of all equipment in the system and the potential hazards involved. When risk to persons or property may be involved, a holding device must be an integral part of the driven equipment beyond the speed reducer and output shaft.

4. Slide the Deflection Indicator Plate so the Cone Point Setscrew is over the 0 on the Load Indicator Plate.

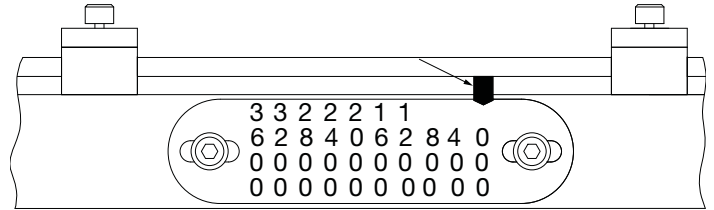

5. Reattach the Upper Guide using 1/4-20NC X 1" screws (included).

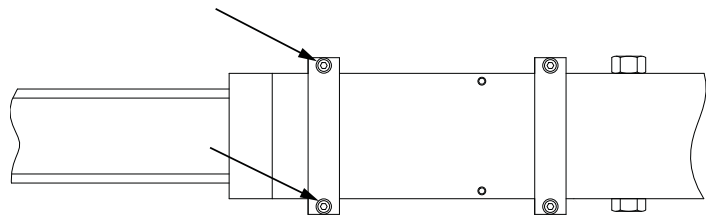

6. Lift the top to insert the bearing and screw assembly.

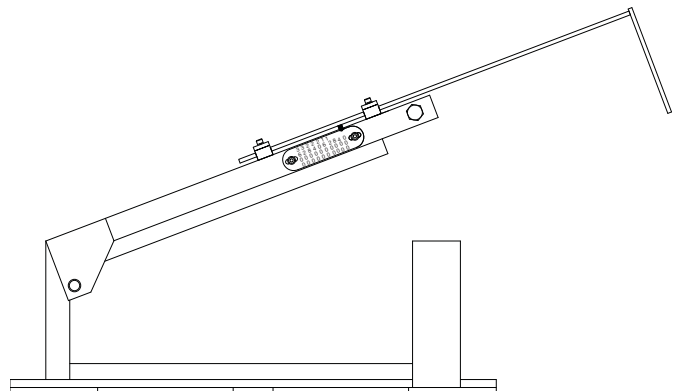

7. Lower the top over the screw assembly. (Note: Washers should be located outside the main frame.)

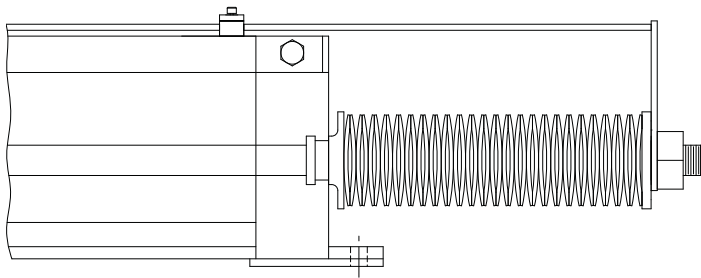

8. The end of the top plate should slip between the outboard washer and hex nut.

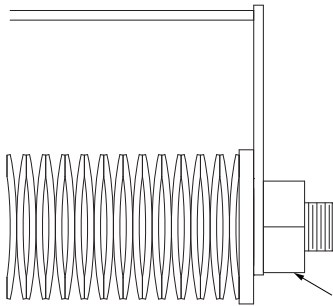

9. Repeat procedure for second take-up.
10. Tighten the TU Nut until the appropriate load* is displayed on the Load Indicator Plate.

***NOTE: Load values denoted on Load indicator Plate are the working load (lbs) for each individual frame. If the desired load is 400lbs, each of the Load Indicating Take-Ups would be set to 200lbs.**

Description	Complete Unit	Screw Assembly *
CPLI-400X12-TUFR	089571	089580
CPLI-502X12-TUFR	089572	089581
CPLI-515X12-TUFR	089573	089582

Screw Assembly consists of TU Screw, Inboard Washer, Bellville Washer, Outboard Washer and TU Nut.

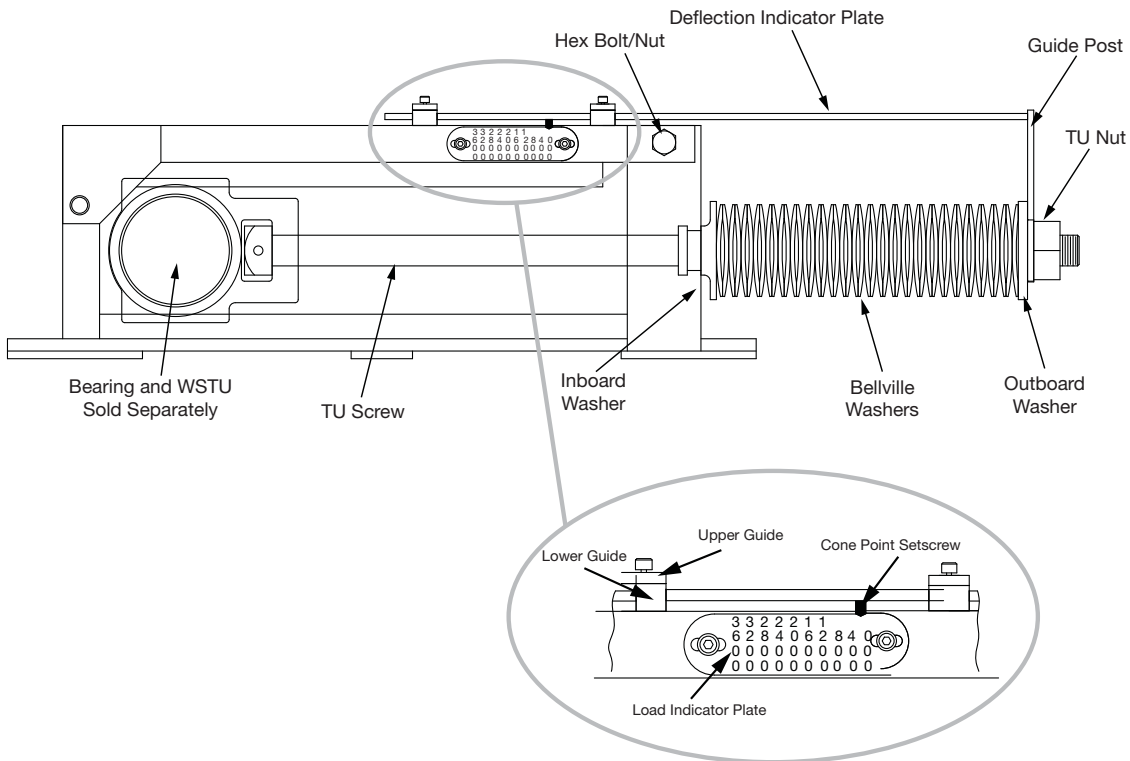

World Headquarters

P.O. Box 2400, Fort Smith, AR 72902-2400 U.S.A., Ph: (1) 479.646.4711, Fax (1) 479.648.5792, International Fax (1) 479.648.5895

Dodge Product Support

6040 Ponders Court, Greenville, SC 29615-4617 U.S.A., Ph: (1) 864.297.4800, Fax: (1) 864.281.2433

www.baldor.com

