

SETScrew MOUNTED BALL BEARINGS

DODGE[®]



BALDOR[®]

SETScrew MOUNTED BALL BEARINGS

For over 65 years, DODGE has provided innovative solutions for the industry's toughest mounted bearing applications. This experience led to the design of the most advanced mounted ball bearing product line in the industry. DODGE ball bearings are built in our state-of-the-art facility in Rogersville, Tennessee using the latest manufacturing technologies to produce the highest quality product available on the market today.

VSC	Value Line
SC	Normal Duty
SCM	Medium Duty
SCED	Extreme Duty
SCMED	Extreme Medium Duty

- 65° setscrew locking system
- Precision-hardened and honed inner and outer rings
- Grade 10 balls
- Wide inner ring design
- Available sizes 1/2" - 3-1/2" (17mm - 70mm)
- Cooler operation for longer grease life
- Housing styles:
 - Pillow Block
 - Tapped Base
 - Flange - 2-Bolt, 3-Bolt, and 4-Bolt
 - Piloted Flange
 - Flange Bracket
 - Screw Conveyor Hanger Bearing
 - Hanger Bearing
 - Cylindrical Unit
 - Take-Up



SC/SCM

VALUE ADDED FEATURES

SUPERIOR LOCKING FORCE

DODGE uses 65° spacing for setscrews. This unique design offers an optimum balance between locking force and inner ring stress.

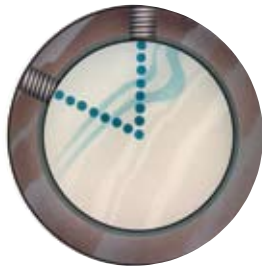

PATENTED DUALGUARD SEAL

DODGE SC/SCM products use the patented DualGuard sealing system that offers maximum protection in tough environments. The DualGuard seal consists of two patented features that are unique to DODGE bearings.

- Land-riding single lip seal
 - Made of nitrile rubber
 - Provides positive contact with the inner ring
 - Assures uniform lip contact to keep contaminants out and seal in lubricant
 - Mechanically retained seal adds strength and allows grease to purge
- Rubberized flinger
 - Industry's first and only patented design
 - Molded rubber provides additional protection against contaminants entering the bearing
 - Baffle design of the rubber on the external surface of the flinger enhances the removal of liquid during rotation
 - Rubber baffles create a turbulent airflow around the seal to help protect against airborne contaminants
 - Grease chambers on the internal surface prevent lubricants from exiting the bearing
 - Superior design increases service life in dirty environments thus leading to extended uptime

STRONGER, MORE FLEXIBLE CAGE

The SC/SCM uses a ball cage that is made of heat stabilized nylon with fiber-glass reinforcement for added strength. The nylon material provides a natural lubricity for longer life. Fiberglass reinforcement allows higher operating temperatures than plain nylon, is more resistant to fatigue than metallic cages, and prevents the cage from retaining moisture in wet environments. Short fiberglass allows greater flexibility than steel or normal fiberglass, especially under misalignment. That means longer life in applications where some degree of misalignment is unavoidable.

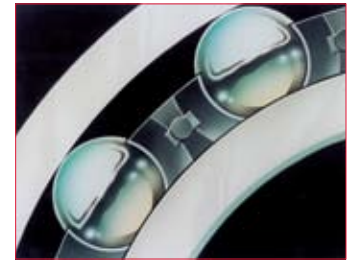

SIMPLIFIED ANTI-ROTATION DEVICE

An anti-rotation pin prevents rotation of the outer race within the housing. Simple and effective, it makes system inserts easier to replace. There is no need to remove and replace grease fittings, location pins or other devices.



Fiberglass Reinforced Nylon Cage

Mechanically Retained Lip Seal

Patented Rubberized Flinger

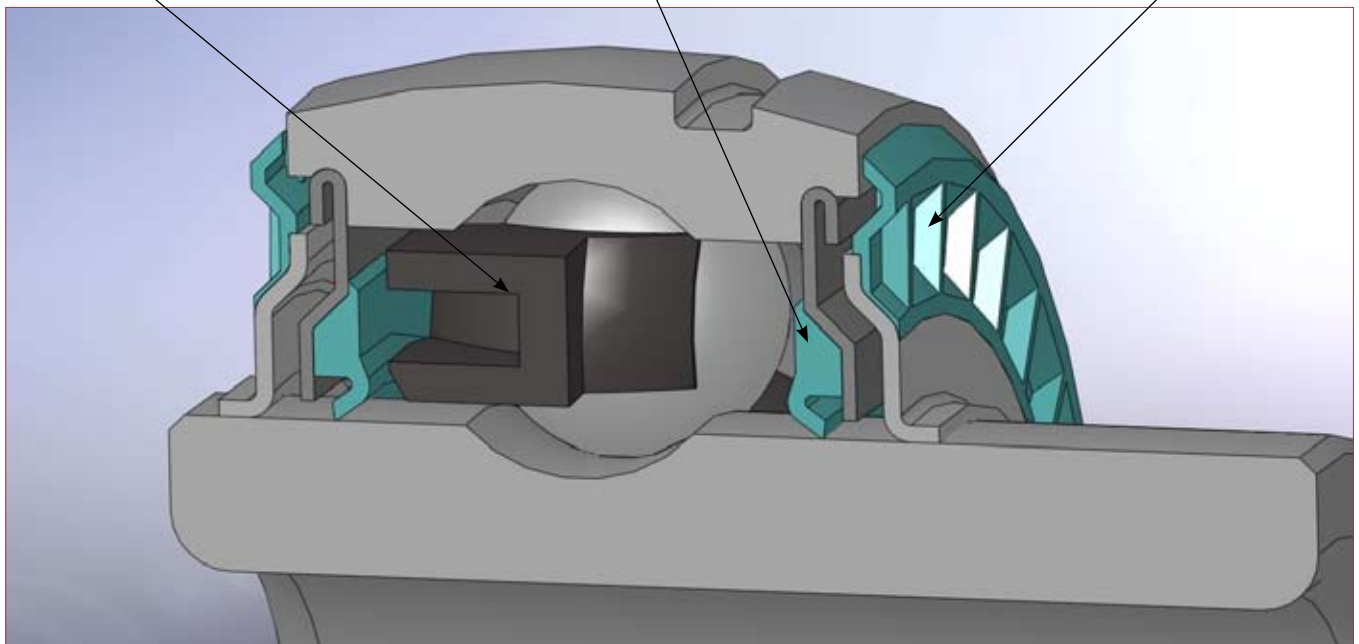

SCED/SCMED—EXTREME DUTY

REDUCED MAINTENANCE

The DODGE SC/SCMED Extreme Duty ball bearing offers extended life in the toughest industrial applications. Incorporating patented DODGE-only features such as the QuadGuard sealing system and the Maxlife ball cage, the DODGE SCED/SCMED bearing outperforms the competition in demanding environments where increasing equipment uptime is critical to success. Extreme conditions require highly-engineered products that will last. The DODGE Extreme Duty ball bearing is up to the challenge.

PATENTED QUADGUARD SEAL

The SCED/SCMED uses our patented QuadGuard sealing system that offers superior protection in tough environments where there is significant risk of contamination. Industries such as aggregates, cement, paper, wood products and metals require a sealing system that will extend the life of the bearing in harsh conditions. There are two major components to the QuadGuard design.

- Triple-lip seal
 - Patented design
 - Mechanically retained seal with two contact points on the inner ring and one contact point that rides against flinger surface
 - Three points of contact guard against contamination and keep in lubricants
 - Maximizes sealing without a significant speed rating reduction compared to a single lip design
- Rubberized flinger
 - Patented design (first in the industry)
 - Molded rubber provides additional protection from contaminants entering the bearing
 - Baffle design of the rubber on the external surface of the flinger enhances the removal of liquid as it rotates
 - Grease chambers on the internal surface prevent lubricants from exiting the bearing
 - Superior design increases service life in dirty environments, thus leading to extended uptime

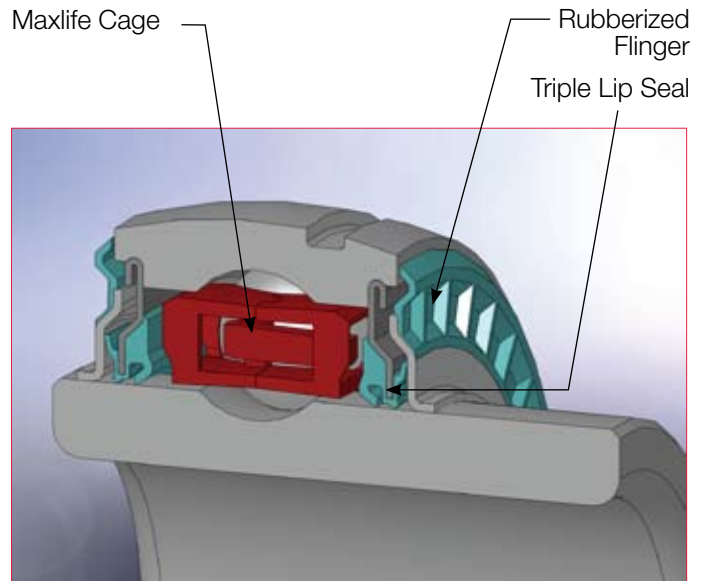

SCED/SCMED PATENTED MAXLIFE BALL CAGE

LESS MAINTENANCE REQUIRED

The SCED/SCMED incorporates an innovative cage design that is unique to DODGE. The Maxlife cage is the product of extensive research and development in retainer technology and industry leading engineering.

- Two-piece design that creates a grease compartment around each of the rolling elements
- Compartments allow balls to be constantly in contact with grease, insuring that an oil film will always exist to prevent wear and minimize friction and heat
- Relative motion between the components and the grease is reduced, resulting in lower operating temperatures and extended life
- Compartmental construction of the cage helps hold in the grease and prevents it from being washed out in extremely wet or dirty conditions
- Exclusive design extends life with less frequency of re-lubrication than standard designs



SYNTHETIC GREASE STANDARD

The SCED/SCMED utilizes the latest in synthetic grease technology to provide lower operating temperatures, extended grease life, and maximum time between re-lubrication. The SC Extreme Duty ball bearing from DODGE offers the ultimate in engineering and innovation to provide a product that requires less maintenance and will last longer in demanding environments.

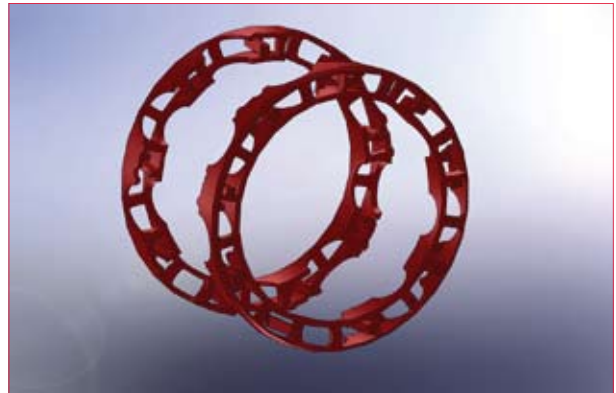

3 YEAR WARRANTY

DODGE SNAP-ON END COVERS

ENHANCED SEALING / SAFER WORK ENVIRONMENT

HOUSING DESIGNED FOR SNAP-ON END COVER

SC/SCM and SCED/SCMED bearings contain a machined groove in the housing to accommodate a snap-on style polymer end cover. The end cover provides additional protection from the environment and creates a safer working environment for employees maintaining equipment. The snap-on style end cover incorporates an additional lip on the mounting surface for a more rigid fit within the housing and enhanced sealing. The design is more durable than a bolt-on style that uses the grease fitting to secure the cover in place and can be easily knocked off the bearing housings. Closed and open end covers are available.

- Available as a standard feature for SC/SCM and SCED/SCMED products
- Machined groove in housing accommodates snap-on style polymer end cover
- Extended lip on the outer diameter of end cover provides a secure fit and positive sealing
- Provides additional layer of protection in harsh environments
- Creates a safer work environment for employees
- OSHA approved yellow
- Closed and open end covers available

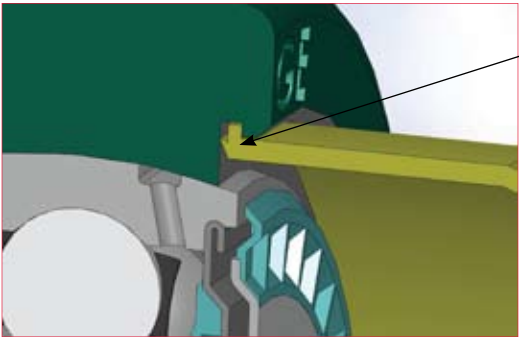

Extended lip provides a secure fit and positive sealing

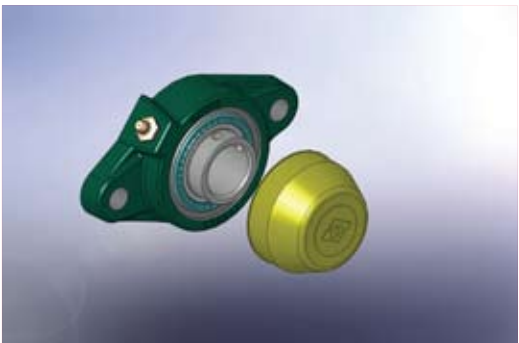

VSC

VALUE LINE OF BALL BEARINGS

Not every application demands features for extended life. For less demanding applications, the DODGE VSC Ball Bearing is the perfect choice. The VSC maintains high quality level expectations by offering the following standard features.

- Fiberglass reinforced nylon cage
- 65° setscrew angle
- Grade 10 balls
- Mechanically retained single lip seal
- American made in Rogersville, Tennessee

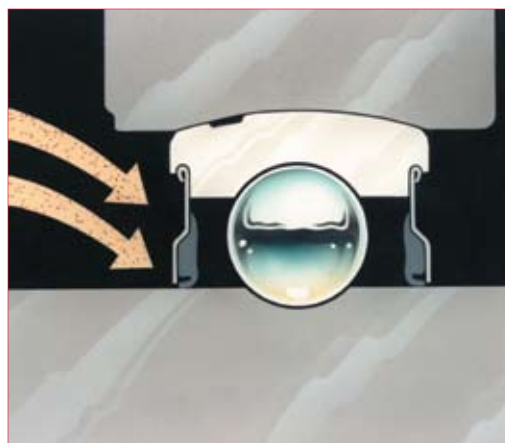

DODGE VSC mounted ball bearings use the field proven PROGUARD land-riding contact seal with steel shield protection. This highly effective positive seal design assures uniform lip contact with the inner ring to seal out contaminants and seal in lubricants.

BALDOR

World Headquarters

P.O. Box 2400, Fort Smith, AR 72902-2400 U.S.A., Ph: (1) 479.646.4711, Fax (1) 479.648.5792, International Fax (1) 479.648.5895

Baldor - Dodge

6040 Ponders Court, Greenville, SC 29615-4617 U.S.A., Ph: (1) 864.297.4800, Fax: (1) 864.281.2433

www.baldor.com