

## INSTALLATION GUIDE

# ABB Ability™ Smart Sensor for pumps

This instruction sheet provides information on the installation of the ABB Ability™ Smart Sensor for pumps using a threaded housing hole. Read these instructions in their entirety before attempting installation.



### ATTENTION

The sensor should be installed by technically qualified personnel. Failure to install the sensor in compliance with applicable codes and regulations and according to the manufacturer's recommendations may result in electrical shock, fire hazard, unsatisfactory performance or equipment failure, and may void the sensor warranty.

### WARNING

Only qualified individuals who are familiar with appropriate national codes, local codes and sound practices should install, repair or modify electric motors and/or related accessories. Installation should conform to appropriate codes and practices. Failure to follow these instructions could result in serious personal injury, death and/or property damage.

### WARNING

**Electrical Live Circuit Hazard.** Do not touch electrically live parts or equipment. Disconnect, lock out and tag out the motor's power supply before installing or servicing the sensor.

### CAUTION

**Surface Temperature Hazard.** The external surface of an electric motor or of the driven pump may reach temperatures which can cause discomfort, burns or injury to individuals who come into contact with the hot surface. For safety reasons, the equipment should be switched off and allowed to cool before attempting to install the sensor. Equipment surface temperatures should only be measured with suitable instruments and not estimated by hand touch or direct skin contact. Failure to observe this precaution could result in bodily injury.

### CAUTION

**Do not replace batteries!** Incorrect use of batteries may void the certifications of the smart sensor, such as hazardous area certifications, safety certifications, and IP rating. Dispose of used sensors according to instructions.

## Sequence for setup

### Step 1 Install the ABB Ability™ Smart Sensor Platform App

- Smart Sensor Platform App can be found in: Apple – App Store, Android – Google Play Store.

**Note:** In some countries these stores may not be accessible. For more information see [www.abb.com/smartsensor](http://www.abb.com/smartsensor).

### Step 2 Register in the ABB Ability™ Smart Sensor Platform App

- Follow the sign up link
- Alternatively, sign up on the web portal at <https://smartsensor.abb.com>
- Skip this step if you are already registered

### Step 3 Log in to ABB Ability™ Smart Sensor App

- Follow the instructions on the screen.

### Step 4 Activate the Smart Sensor with the ABB Ability™ Smart Sensor App

- Follow the instructions on the screen.

### Step 5 Install ABB Ability™ Smart Sensor

- Verify that you have the right components and install the sensor according to the instructions on pages 3 and 4.
- Follow the safety instructions carefully.

### Step 6 Add the pump in the ABB Ability™ Smart Sensor App

### Step 7 Take first measurements and check the pump condition

### Step 8 For more detailed instructions

- Visit [www.abb.com/smartsensor](http://www.abb.com/smartsensor).

## Items needed





**WARNING:** Changes to the pump must only be performed by the OEM or an authorized service technician.

### Items included in the ABB Ability™ Smart Sensor for pumps kit:

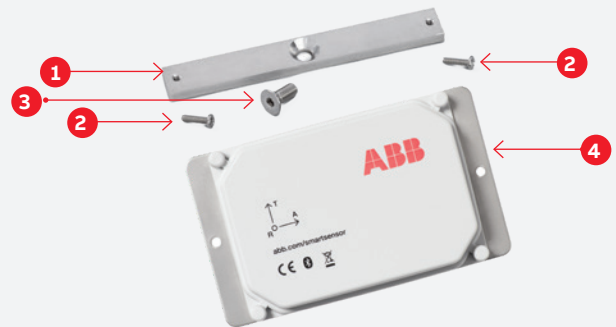
- **1** Mounting bracket
- **2** Phillips head screws (2 qty) M4-0.7 x 10 mm
- **3** Tapered hex Drive Flat Head Screw (1 qty) 1/4" x 5/8" (UNF 28)
- **4** ABB Ability™ Smart Sensor for pumps



### Additional items needed but not included in the kit:

- Rubber gloves
- Allen wrench (4 mm or 5/32") 
- Small Phillips head screw driver 
- Leveling tool

## Installation notes

### Where to mount:

1. The sensor must be mounted on the pump housing above the drive-end bearing of the pump, closest to the motor coupling.
2. For best Bluetooth® communication, mount the sensor with a clear line of sight to any communication devices to be used: your smartphone or a Bluetooth® gateway.
3. The mounting orientation must be such that the A-axis on the sensor housing is parallel to the rotating shaft. If this is not physically possible, the T-axis must be parallel to the rotating shaft.

## Supported pump specifications

**Pump type:** Centrifugal or vortex pump

**Fluid type:** Water or wastewater

**Maximum number of impeller blades:**  $b_{MIN} = 2$ ,  $b_{MAX} = 8$

### Speed type and range

- Direct online or variable-speed (VSD);
- MIN = 500 RPM; MAX = (750 RPM x b); b: no. of blades

### Power / size:

- The driving motor's frame must be supported by the Smart Sensor, i.e. up to 450 mm



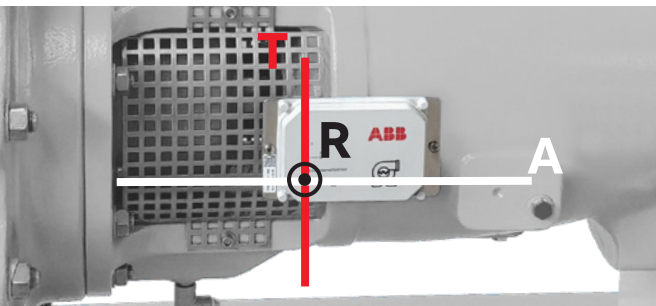
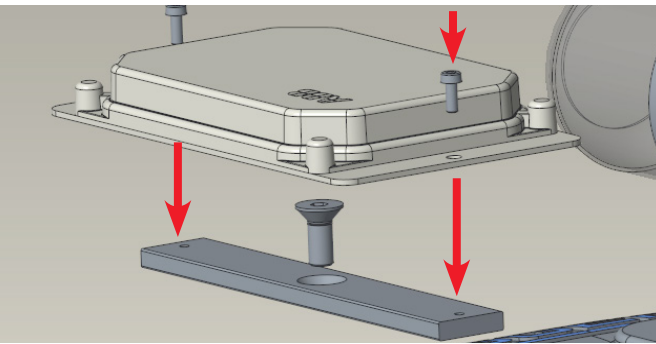
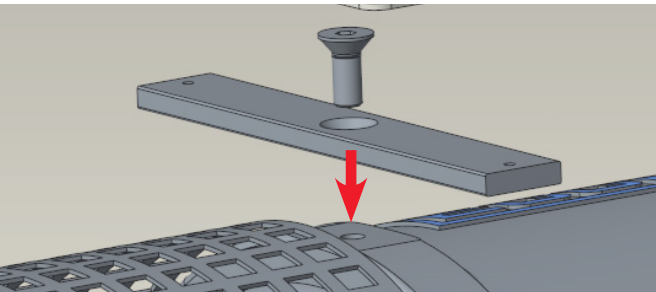
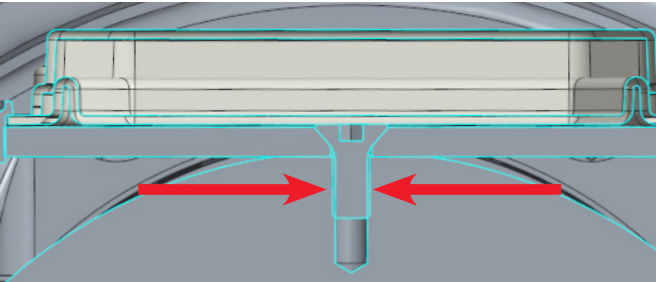

## Installation steps

### Step 1

Ensure that a threaded bore matching the dimensions of the mounting bracket's hex head screw is present directly on the housing.



**CAUTION: CHANGES TO THE HOUSING MUST ONLY BE PERFORMED BY THE OEM OR AN AUTHORIZED SERVICE TECHNICIAN.**

### Step 2

Fasten mounting bracket directly onto the threaded bore on the housing.

**Ensure that the central hex head screw is locked 1mm above the bracket for best heat and vibration transmission!**

If necessary, apply Loctite™ Blue or equivalent threadlocker to thread, and appropriate glue between the bracket and the housing in order to prevent rotation.



**CAUTION: REVIEW AND FOLLOW ALL MANUFACTURER'S INSTRUCTIONS AND SAFETY PRECAUTIONS WHEN USING THREADLOCKER AND INDUSTRIAL GLUES.**

### Step 3

Fasten the Smart Sensor onto the mounting bracket using the two lateral Phillips head screws.

### Step 4

Verify the alignment with a level. The axial direction (white line) must be parallel to the pump shaft. The tangential axis (red line) should be at a right angle to the previous one, on a plane tangential to the housing. The radial direction (black line) points towards the center line of the shaft.

If this is not possible, the T-axis must be parallel to the rotating shaft.

### Next step

Digitally connect Smart Sensor using the ABB Ability™ Smart Sensor app. Log on using your myABB credentials and follow the prompts to connect.

---

## For questions and support, please contact

ABB  
Motors and Generators Service

Product information  
[www.abb.com/smartsensor](http://www.abb.com/smartsensor)

Support e-mail address  
[support.smartsensor@abb.com](mailto:support.smartsensor@abb.com)

### NOTE

We reserve the right to make technical changes or modify the contents of this document without prior notice. With regard to purchase orders, the agreed particulars shall prevail. ABB Ltd does not accept any responsibility whatsoever for potential errors or possible lack of information in this document.

We reserve all rights in this document and in the subject matter and illustrations contained therein. Any reproduction, disclosure to third parties or utilization of its contents – in whole or in parts – is forbidden without prior written consent of ABB Ltd.

Copyright© 2019 ABB, All rights reserved