

# ABB BALDOR RELIANCE III

---

## Customer information packet

### EJPM3713T

15HP, 3495RPM, 3PH, 60HZ, 215JP, 3744M, TEFC, F

Class - None

Division - Not Applicable

**Specifications**

<b>Enclosure</b>	TEFC
<b>Frame</b>	215JP
<b>Frame Material</b>	Steel
<b>Frequency</b>	60.00 Hz
<b>Haz Area Class and Group</b>	None
<b>Haz Area Division</b>	Not Applicable
<b>Motor Letter Type</b>	Three Phase
<b>Output @ Frequency</b>	15.000 HP @ 60 HZ
<b>Phase</b>	3
<b>Synchronous Speed @ Frequency</b>	3600 RPM @ 60 HZ
<b>Voltage @ Frequency</b>	230.0 V @ 60 HZ 460.0 V @ 60 HZ
<b>Agency Approvals</b>	NEMA PREMIUM CURUSEEV
<b>Ambient Temperature</b>	40 °C
<b>Auxiliary Box</b>	NO AUXILLARY BOX
<b>Auxiliary Box Lead Termination</b>	None
<b>Base Indicator</b>	Rigid
<b>Bearing Grease Type</b>	Polyrex EM (-20F +300F)
<b>Blower</b>	None
<b>Current @ Voltage</b>	17.700 A @ 460.0 V 35.500 A @ 230.0 V
<b>Design Code</b>	B
<b>Drip Cover</b>	No Drip Cover
<b>Duty Rating</b>	CONT
<b>Efficiency @ 100% Load</b>	91.0 %
<b>Electrically Isolated Bearing</b>	Not Electrically Isolated
<b>Feedback Device</b>	NO FEEDBACK
<b>Front Shaft Indicator</b>	None
<b>Heater Indicator</b>	No Heater
<b>High Voltage Full Load Amps</b>	17.7 a
<b>Insulation Class</b>	F

**Part Detail**

<b>Revision</b>	A
<b>Type</b>	AC
<b>Mech. spec.</b>	37L079
<b>Base</b>	
<b>Status</b>	PRD/A
<b>Elec. spec.</b>	37WGZ713
<b>Layout</b>	37LYL079
<b>Eff. date</b>	04-06-2026
<b>CD Diagram</b>	CD0180
<b>Poles</b>	02
<b>Leads</b>	9#14
<b>Proprietary</b>	False
<b>Created date</b>	11-10-2025

<b>Inverter Code</b>	Inverter Ready
<b>KVA Code</b>	H
<b>Lifting Lugs</b>	Standard Lifting Lugs
<b>Locked Bearing Indicator</b>	Locked Bearing
<b>Motor Lead Quantity/Wire Size</b>	9 @ 14 AWG
<b>Motor Lead Termination</b>	Flying Leads
<b>Motor Standards</b>	NEMA
<b>Motor Type</b>	3744M
<b>Mounting Arrangement</b>	F1
<b>Number of Poles</b>	2
<b>Overall Length</b>	24.76 IN
<b>Power Factor</b>	86
<b>Product Family</b>	General Purpose
<b>Pulley End Bearing Type</b>	Ball
<b>Pulley Face Code</b>	C-Face
<b>Pulley Shaft Indicator</b>	Tapped & Key
<b>Rodent Screen</b>	None
<b>RoHS Status</b>	ROHS COMPLIANT
<b>Service Factor</b>	1.15
<b>Shaft Diameter</b>	1.250 IN
<b>Shaft Ground Indicator</b>	No Shaft Grounding
<b>Shaft Rotation</b>	Reversible
<b>Shaft Slinger Indicator</b>	No Slinger
<b>Speed</b>	3495 rpm
<b>Speed Code</b>	Single Speed
<b>Starting Method</b>	Direct on line
<b>Thermal Device - Bearing</b>	None
<b>Thermal Device - Winding</b>	None
<b>Vibration Sensor Indicator</b>	No Vibration Sensor
<b>Winding Thermal 1</b>	None
<b>Winding Thermal 2</b>	None

**Nameplate**

**NP3441LUA**

<b>CAT.NO.</b>	EJPM3713T						
<b>SPEC</b>	37L079Z713						
<b>HP</b>	15						
<b>VOLTS</b>	230/460						
<b>AMPS</b>	35.5/17.7						
<b>RPM</b>	3495						
<b>FRAME</b>	215JP	<b>HZ</b>	60	<b>PH</b>	3		
<b>SF</b>	1.15	<b>CODE</b>	J	<b>DES</b>	A	<b>CLASS</b>	F
<b>NEMA NOM. EFF</b>	91	<b>PF</b>	86				
<b>RATING</b>	40C AMB-CONT						
<b>CC</b>	010A						
<b>ENCL</b>	TEFC	<b>SER</b>					
<b>DE</b>	6309	<b>ODE</b>	6206				
<b>VPWM INVERTER READY</b>	SFA 40.4/20.2						
<b>CT6-60H(10:1)VT3-60H(20:1</b>	50HZ 15HP 190/380V 40.8/20.4A						SF1.0

ABB Motors and Mechanical Inc.

WINDING # 37WGZ713

Typical performance - not guaranteed values.

15 HP 3 PH 60 HZ 3495 RPM 460 V 3744M

TORQUES (LB-FT): PO=119 PU=38 LR=54.1 LRA=146

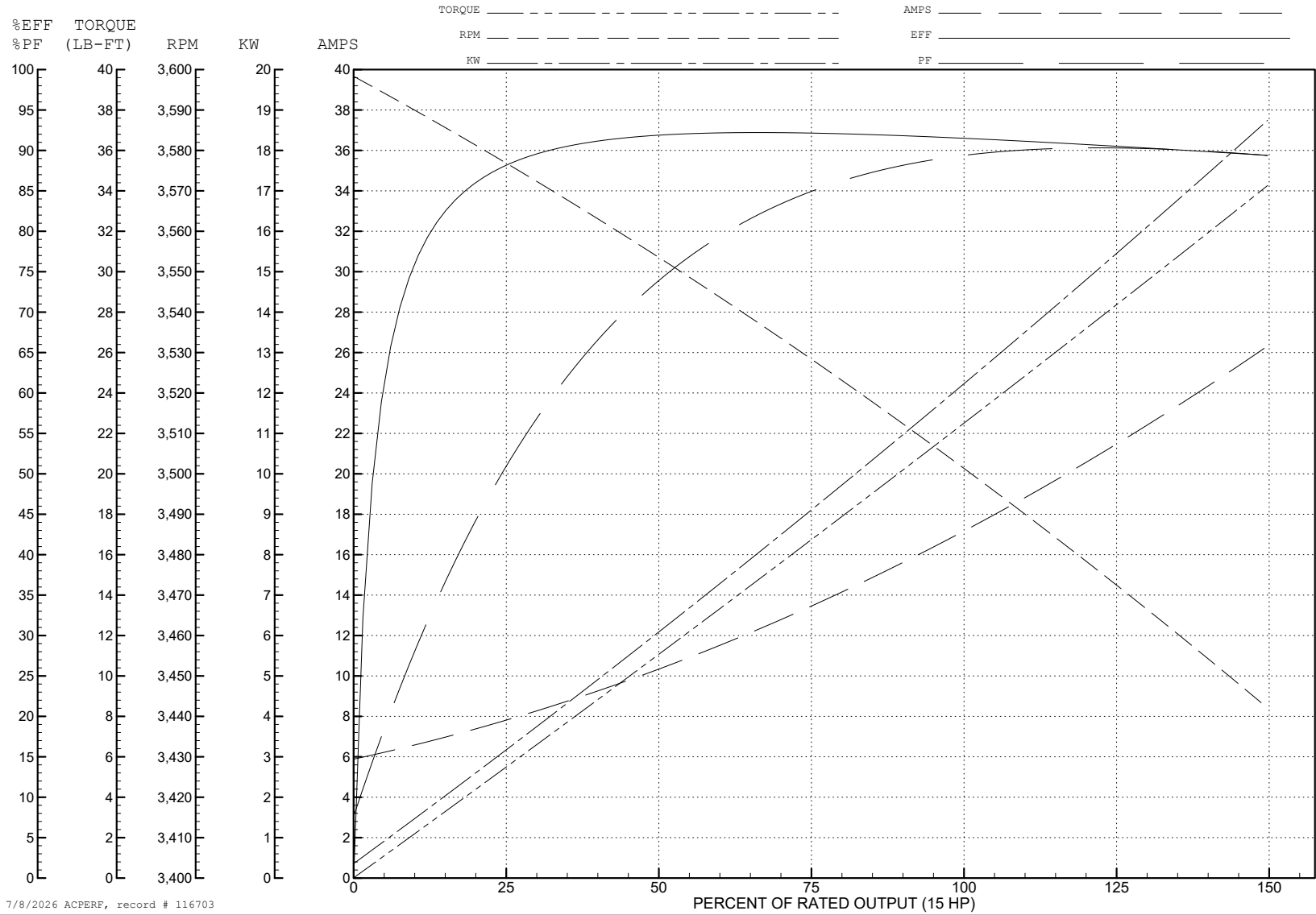

7/8/2026 ACPERF, record # 116703

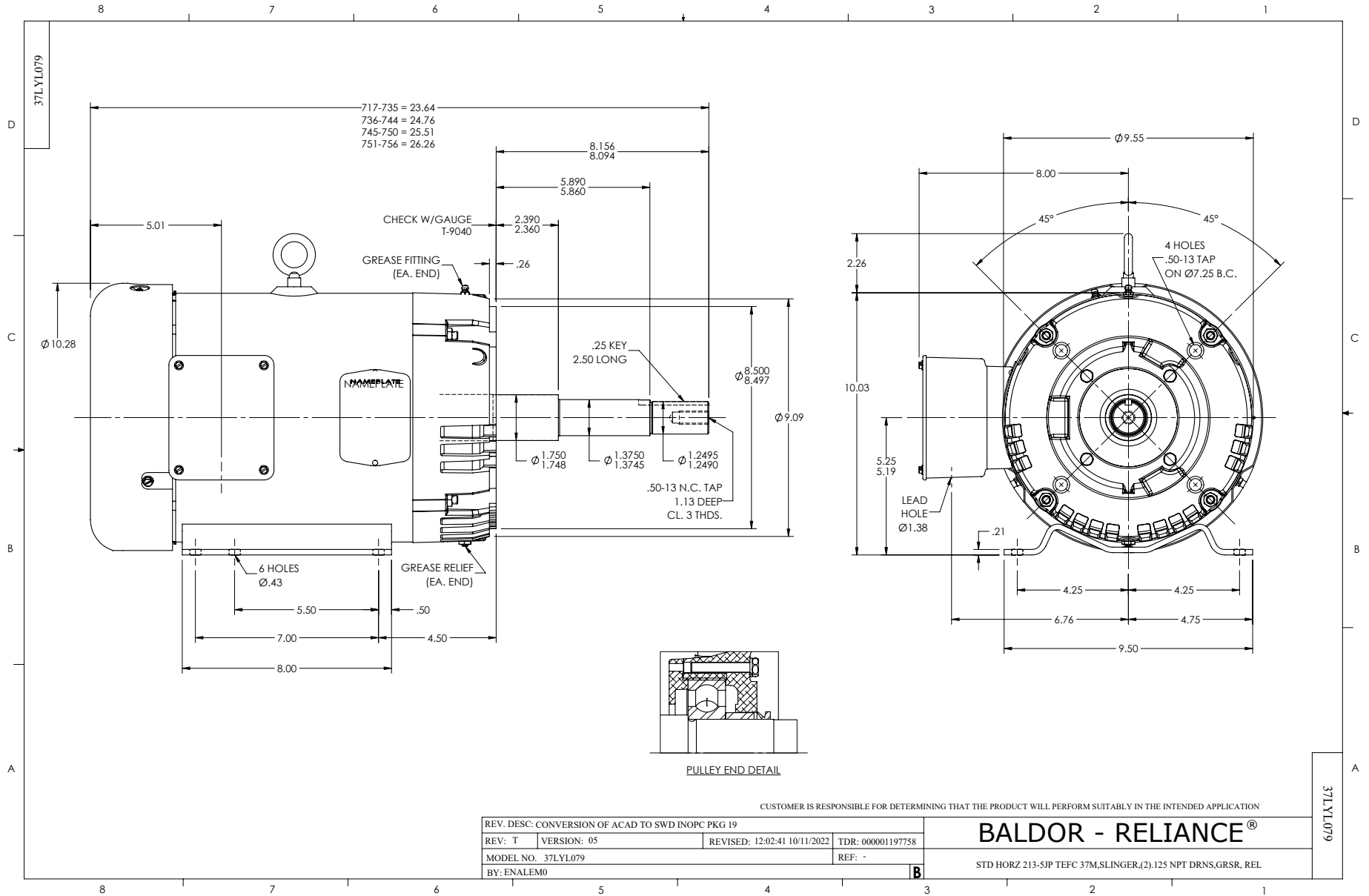

CD0180

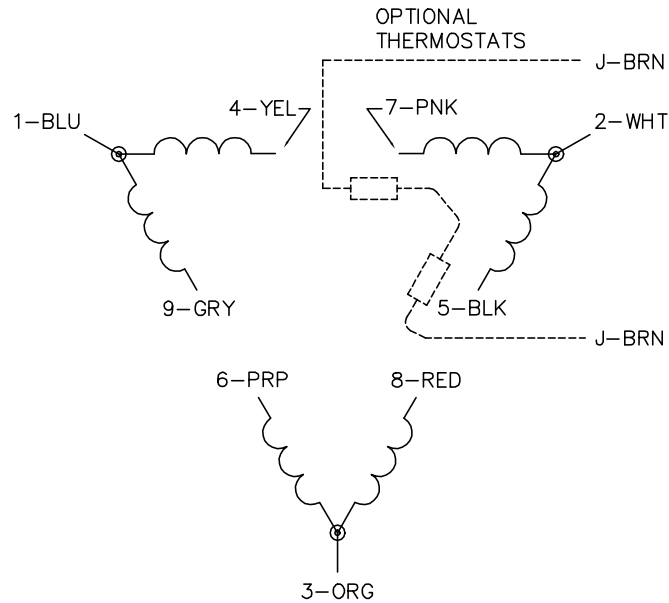

LOW VOLTAGE  
(2D)

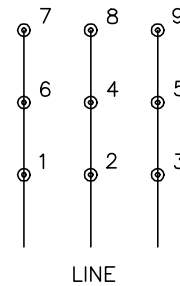

HIGH VOLTAGE  
(1D)

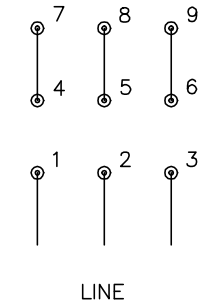

NOTES:

1. INTERCHANGE ANY TWO LINE LEADS TO REVERSE ROTATION.
2. OPTIONAL THERMOSTATS ARE PROVIDED WHEN SPECIFIED.
3. ACTUAL NUMBER OF INTERNAL PARALLEL CIRCUITS MAY BE A MULTIPLE OF THOSE SHOWN ABOVE.
4. LEAD COLORS ARE OPTIONAL. LEADS MUST ALWAYS BE NUMBERED AS SHOWN.

CD0180

REV. DESC: ADD CLASS CONN00000007		
REV. LTR: D	VERSION: 01	TDR: 000001099922
FILE: \AAA\00005\148	REVISED: 10: 25: 29 02/19/2019	BY: ENBRIRO
MTL: -	© □	

**BALDOR - RELIANCE®**

3PH, DV, 9 LEADS, DELTA CONNECTION

SH 1 of 1