

# ABB BALDOR RELIANCE III

---

## Customer information packet

EHM2515T-8

20HP, 1765RPM, 3PH, 60HZ, 256T, 3948M, OPSB, F1

Class - None

Division - Not Applicable

**Specifications**

<b>Enclosure</b>	OPSB
<b>Frame</b>	256T
<b>Frame Material</b>	Steel
<b>Frequency</b>	60.00 Hz
<b>Haz Area Class and Group</b>	None
<b>Haz Area Division</b>	Not Applicable
<b>Motor Letter Type</b>	Three Phase
<b>Output @ Frequency</b>	20.000 HP @ 60 HZ
<b>Phase</b>	3
<b>Synchronous Speed @ Frequency</b>	1800 RPM @ 60 HZ
<b>Voltage @ Frequency</b>	200.0 V @ 60 HZ
<b>Agency Approvals</b>	UR CSA
<b>Ambient Temperature</b>	40 °C
<b>Auxiliary Box</b>	NO AUXILLARY BOX
<b>Auxiliary Box Lead Termination</b>	None
<b>Base Indicator</b>	Rigid
<b>Bearing Grease Type</b>	Polyrex EM (-20F +300F)
<b>Blower</b>	None
<b>Current @ Voltage</b>	55.000 A @ 200.0 V
<b>Design Code</b>	A
<b>Drip Cover</b>	No Drip Cover
<b>Duty Rating</b>	CONT
<b>Efficiency @ 100% Load</b>	93.0 %
<b>Electrically Isolated Bearing</b>	Not Electrically Isolated
<b>Feedback Device</b>	NO FEEDBACK
<b>Front Face Code</b>	Standard
<b>Front Shaft Indicator</b>	None
<b>Heater Indicator</b>	No Heater
<b>High Voltage Full Load Amps</b>	55.0 a
<b>Insulation Class</b>	F
<b>Inverter Code</b>	Inverter Ready

**Part Detail**

<b>Revision</b>	M
<b>Type</b>	AC
<b>Mech. spec.</b>	39R006
<b>Base</b>	
<b>Status</b>	PRD/A
<b>Elec. spec.</b>	39WGX981
<b>Layout</b>	39LYR006
<b>Eff. date</b>	12-12-2025
<b>CD Diagram</b>	CD0695
<b>Poles</b>	04
<b>Leads</b>	6#8
<b>Proprietary</b>	False
<b>Created date</b>	06-20-2016

<b>KVA Code</b>	G
<b>Lifting Lugs</b>	Standard Lifting Lugs
<b>Locked Bearing Indicator</b>	No Locked Bearing
<b>Motor Lead Exit</b>	Ko Box
<b>Motor Lead Quantity/Wire Size</b>	6 @ 8 AWG
<b>Motor Lead Termination</b>	Flying Leads
<b>Motor Standards</b>	NEMA
<b>Motor Type</b>	3948M
<b>Mounting Arrangement</b>	F1
<b>Number of Poles</b>	4
<b>Overall Length</b>	23.19 IN
<b>Power Factor</b>	85
<b>Product Family</b>	General Purpose
<b>Pulley End Bearing Type</b>	Ball
<b>Pulley Face Code</b>	Standard
<b>Pulley Shaft Indicator</b>	Standard
<b>Rodent Screen</b>	None
<b>Service Factor</b>	1.15
<b>Shaft Diameter</b>	1.625 IN
<b>Shaft Extension Location</b>	Pulley End
<b>Shaft Ground Indicator</b>	No Shaft Grounding
<b>Shaft Rotation</b>	Reversible
<b>Shaft Slinger Indicator</b>	No Slinger
<b>Speed</b>	1765 rpm
<b>Speed Code</b>	Single Speed
<b>Starting Method</b>	Part Winding
<b>Thermal Device - Bearing</b>	None
<b>Thermal Device - Winding</b>	None
<b>Vibration Sensor Indicator</b>	No Vibration Sensor
<b>Winding Thermal 1</b>	None
<b>Winding Thermal 2</b>	None

**Nameplate**

<b>NP2094E06B03</b>									
<b>CAT.NO.</b>	EHM2515T-8								
<b>SPEC.</b>	39R006X981G1								
<b>HP</b>	20								
<b>VOLTS</b>	200								
<b>AMPS</b>	55								
<b>RPM</b>	1765								
<b>FRAME</b>	256T		<b>HZ</b>	60		<b>PH</b>	3		
<b>SER.F.</b>	1.15	<b>CODE</b>	G	<b>DES</b>	A	<b>CL</b>	F		
<b>NEMA-NOM-EFF</b>	93		<b>PF</b>	85					
<b>RATING</b>	40C AMB-CONT								
<b>CC</b>	010A		<b>USABLE AT 208V</b>				N/A		
<b>DE</b>	6309		<b>ODE</b>	6208					
<b>AUTO</b>		<b>MANUAL</b>			<b>NONE</b>				
<b>ENCL</b>	OPSB	<b>SN</b>							
<b>BLANK</b>									

ABB Motors and Mechanical Inc.

WINDING # 39WGX981

Typical performance - not guaranteed values.

20 HP 3 PH 60 HZ 1765 RPM 200 V 3948M

TORQUES (LB-FT): PO=182 PU=76.1 LR=109 LRA=350

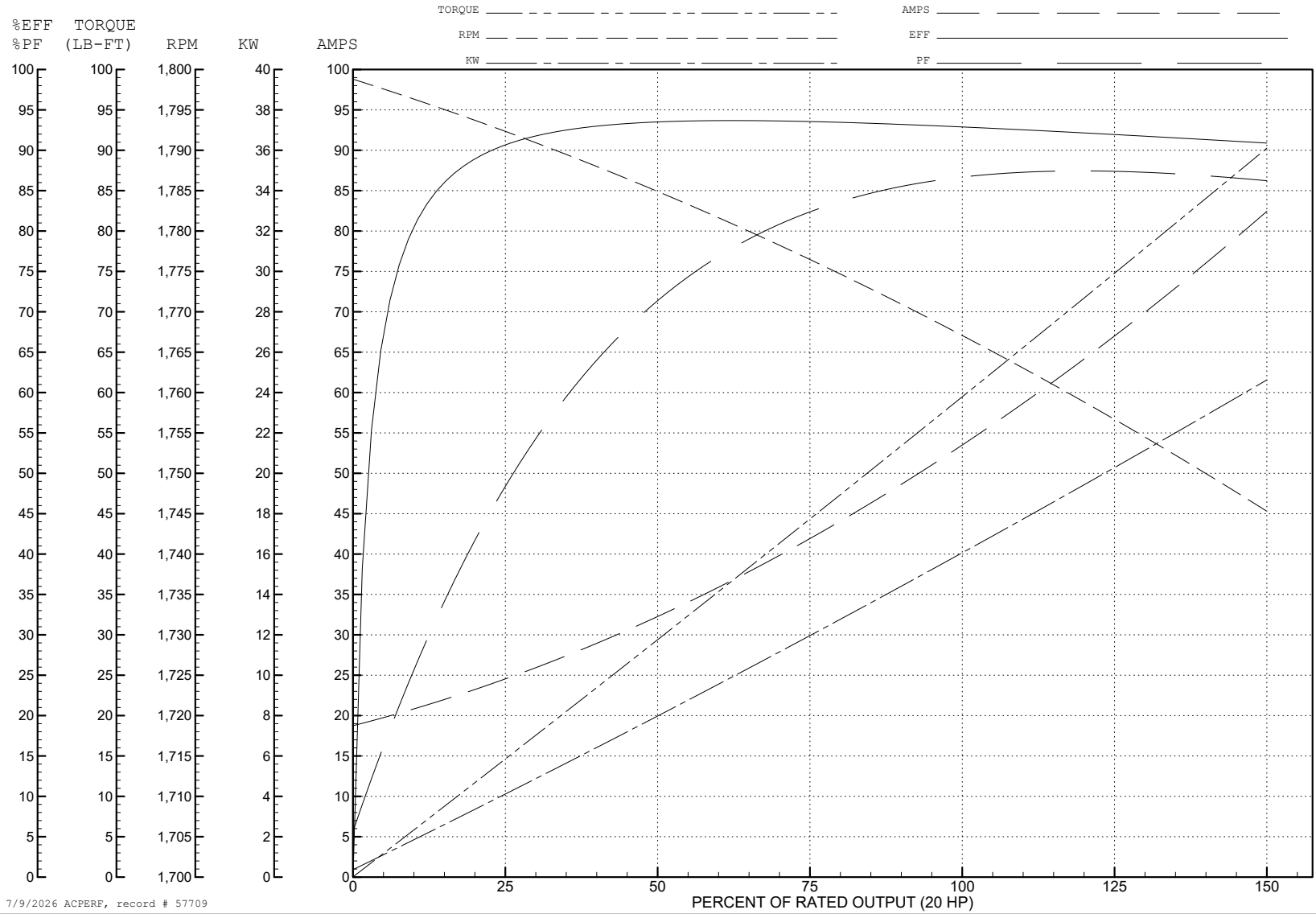

7/9/2026 ACPERF, record # 57709

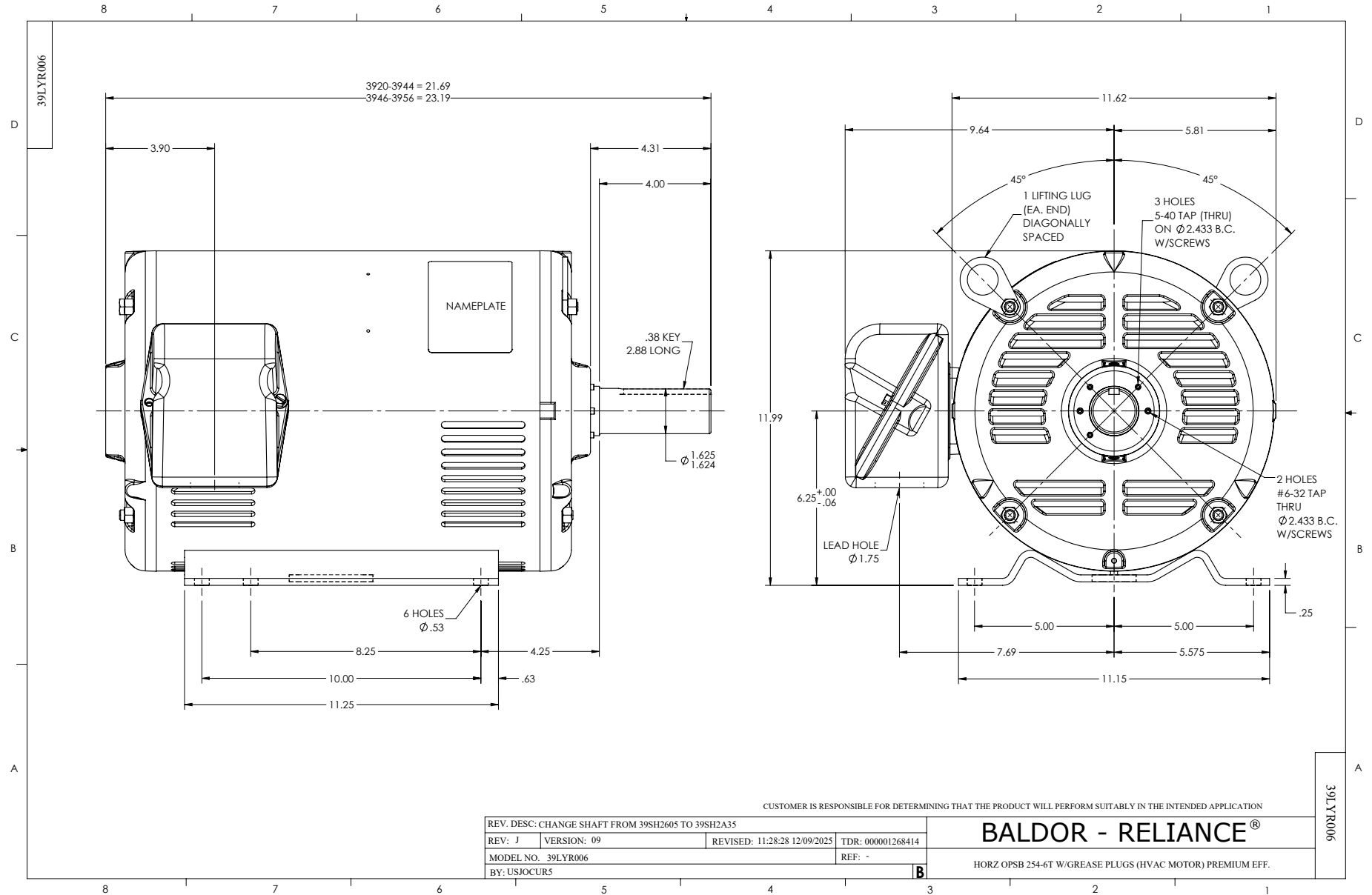

CD0695

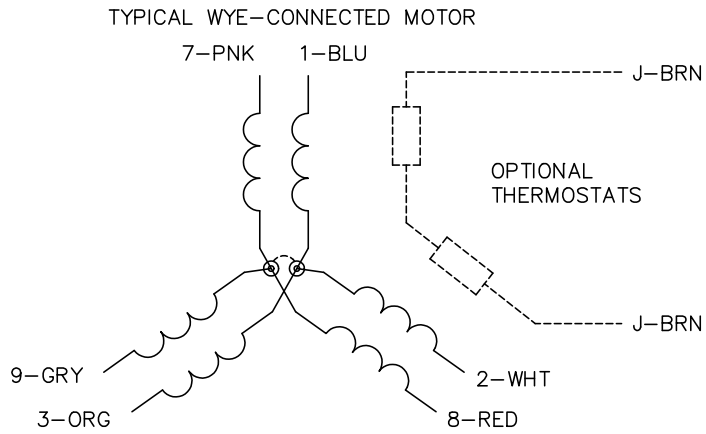

START CONNECTION

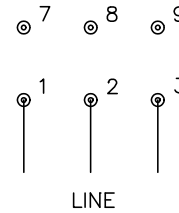

RUN CONNECTION

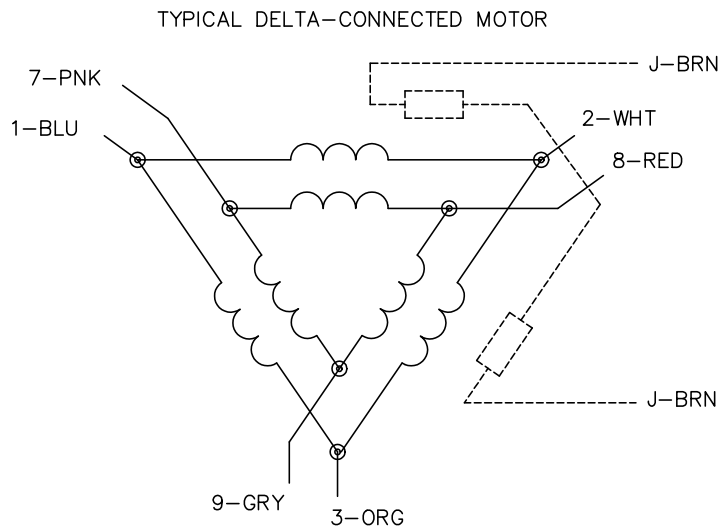
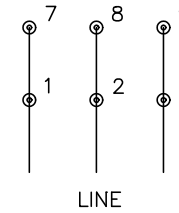

NOTES:

1. MOTOR MAY BE WYE CONNECTED OR DELTA CONNECTED.
2. INTERCHANGE ANY TWO LINE LEADS TO REVERSE ROTATION.
3. OPTIONAL THERMOSTATS ARE PROVIDED WHEN SPECIFIED.
4. ACTUAL NUMBER OF INTERNAL PARALLEL CIRCUITS MAY VARY.
5. LEAD COLORS ARE OPTIONAL. LEADS MUST ALWAYS BE NUMBERED AS SHOWN.

CD0695

REV. DESC: REVISE TO SHOW OPTIONAL COLORS

REV. LTR: C

BY: JLP

REVISED: 01/21/99 3:19

TDR: 0171435

S69000

FILE: AAA00005151

MDL: -

MTL: -

**BALDOR ELECTRIC Co.**

3PH, SV, 6 LEADS, PART WINDING START

CD0006

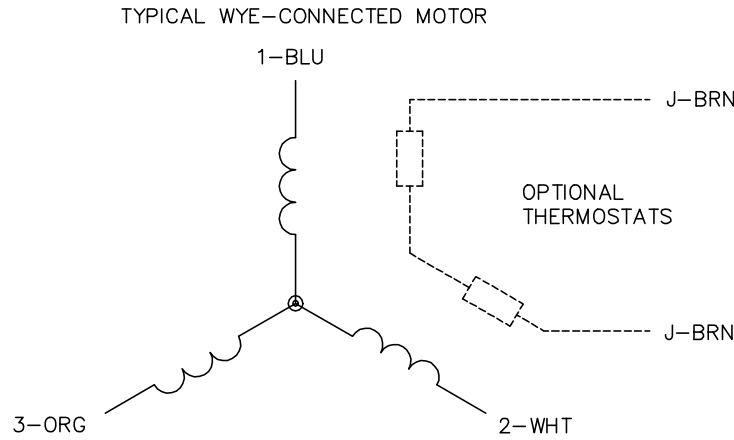

NOTES:

1. THREE LEAD MOTOR MAY BE EITHER WYE CONNECTED OR DELTA CONNECTED.
2. INTERCHANGE ANY TWO LINE LEADS TO REVERSE ROTATION.
3. OPTIONAL THERMOSTATS ARE PROVIDED WHEN SPECIFIED.
4. ACTUAL NUMBER OF INTERNAL PARALLEL CIRCUITS MAY VARY.
5. LEAD COLORS ARE OPTIONAL. LEADS MUST BE NUMBERED AS SHOWN.

CD0006

REV. DESC: ADD CLASS CONN00000007		
REV. LTR: E	VERSION: 01	TDR: 000001099922
FILE: \AAA\00005\141	REVISED: 10:24:49 02/19/2019	BY: ENBRIRO
MTL: -	© □	

**BALDOR - RELIANCE®**

3PH, SV, 3 LEADS, WYE OR DELTA CONNECTED

SH 1 of 1