

BALDOR • RELIANCE

Customer information packet

ECS100A4H5EC4

5HP, 1800RPM, 3PH, 60HZ, 184TC, 3632B, TEFC, F1

Class - None

Division - Not Applicable

Specifications

Enclosure	TEFC
Frame	184TC
Frame Material	Steel
Frequency	60.00 Hz
Haz Area Class and Group	None
Haz Area Division	Not Applicable
Motor Letter Type	Three Phase
Output @ Frequency	5.000 HP @ 60 HZ
Phase	3
Synchronous Speed @ Frequency	1800 RPM @ 60 HZ
Voltage @ Frequency	460.0 V @ 60 HZ
Agency Approvals	UL WEEE
Ambient Temperature	40 °C
Auxillary Box	No Auxillary Box
Auxillary Box Lead Termination	None
Base Indicator	No Mounting
Bearing Grease Type	Polyrex EM (-20F +300F)
Blower	None
Constant Torque Speed Range	6
Current @ Voltage	5.300 A @ 460.0 V
Drip Cover	No Drip Cover
Duty Rating	CONT
Efficiency @ 100% Load	93.7 %
Electrically Isolated Bearing	Not Electrically Isolated
Feedback Device	NO FEEDBACK
Heater Indicator	No Heater
High Voltage Full Load Amps	5.3 a
Insulation Class	F
Inverter Code	Inverter Duty
IP Rating	NONE
Lifting Lugs	Standard Lifting Lugs

Part detail

Revision	G
Type	AC
Mech. spec.	
Base	
Status	PRD/A
Elec. spec.	36WGA0022
Layout	36LYT290
Eff. date	05-08-2024
CD Diagram	CD0006B03
Poles	04
Leads	3#12 15" LONG LEADS
Proprietary	False
Created date	09-28-2020

Locked Bearing Indicator	Locked Bearing
Motor Lead Termination	Flying Leads
Motor Standards	NEMA
Motor Type	3632B
Mounting Arrangement	F1
Number of Poles	4
Overall Length	22.25 IN
Power Factor	97
Product Family	General Purpose
Pulley Face Code	C-Face
Rodent Screen	None
Service Factor	1.00
Shaft Diameter	1.125 IN
Shaft Ground Indicator	Shaft Grounding
Shaft Rotation	Reversible
Speed	1800 rpm
Speed Code	Single Speed
Starting Method	Direct on line
Thermal Device - Bearing	None
Thermal Device - Winding	None
Vibration Sensor Indicator	No Vibration Sensor
Winding Thermal 1	None
Winding Thermal 2	None

Nameplate

NP3978A01

PART NO.	ECI4A5P8				
U1	480	PH	3	HZ	60
I1	7.1	W/EXT. CHOKE			6.0
SERIAL #					

NP3968A01A01

CAT.NO.	ECS100A4H5EC4						
SPEC.	36-0001713						
FRAME	184TC	ENCL.	TEFC	IP	54		
HP	5	40	C AMB	CONT			
NOM. EFF.	93.7	PF	97	SF	1		
VOLTS	460		FLA	5.3			
RPM	1800		RPM-MAX	4000			
HZ	60		PH.	3	CLASS	F	
BEMF (V)	252		RS (OHMS)	3.30			
LD (MH)	54.0		LQ (MH)	191.0			
VPWM	CHP	60	TO	133			
CT	6	TO	60	VT	1	TO	133
MATCHED INV	ECI4A5P8						
DE	6206		ODE	6205			
SERIAL #							

36LYT290

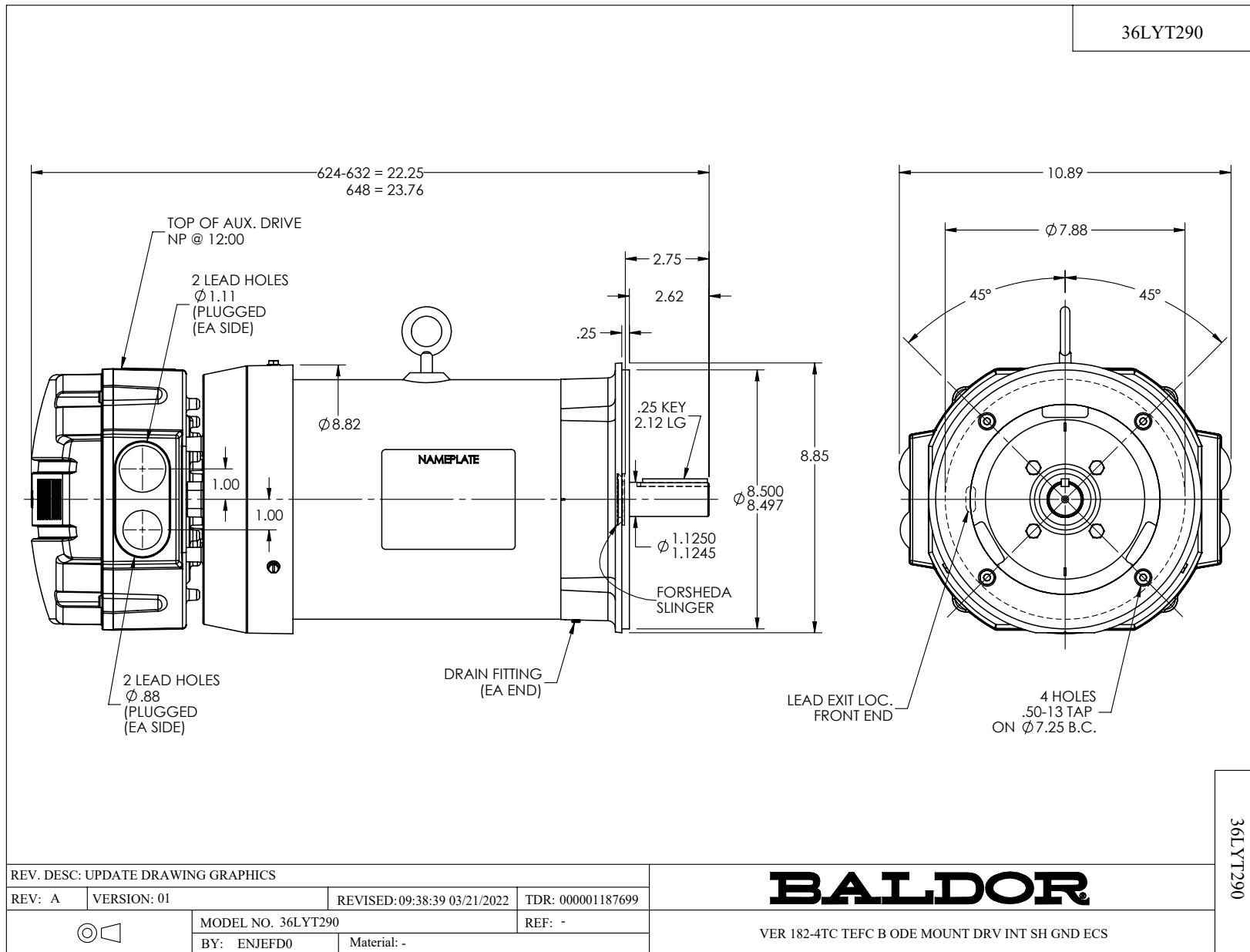

36CB3500A00

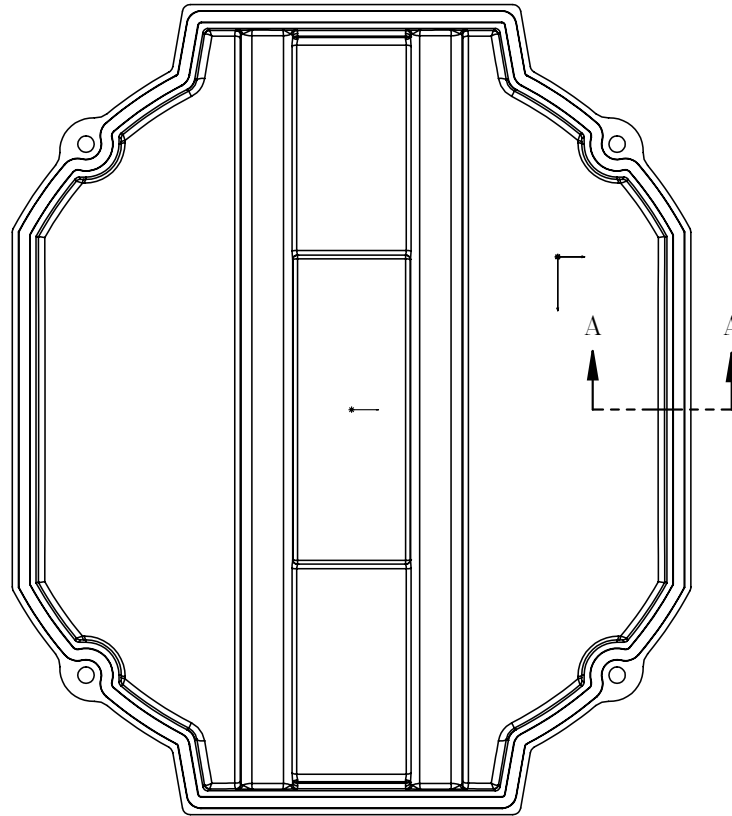

MATERIAL: RAMPF, RAKU-PUR 32-3280-51L

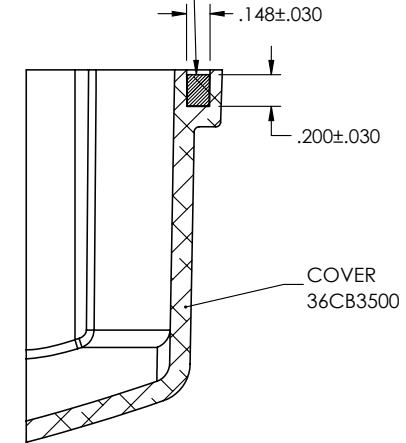

SECTION A-A

36CB3500A00

REV. DESC: UPDATE MATERIAL

REV: A	VERSION: 01	REVISED: 10:45:08 03/29/2019	TDR: 000001101646
--------	-------------	------------------------------	-------------------



MODEL NO. 36CB3500A00	REF: -
BY: ENMARS0	Material: -

BALDOR - RELIANCE®

36 FRAME ODE ECM COVER WITH FOAM SEAL

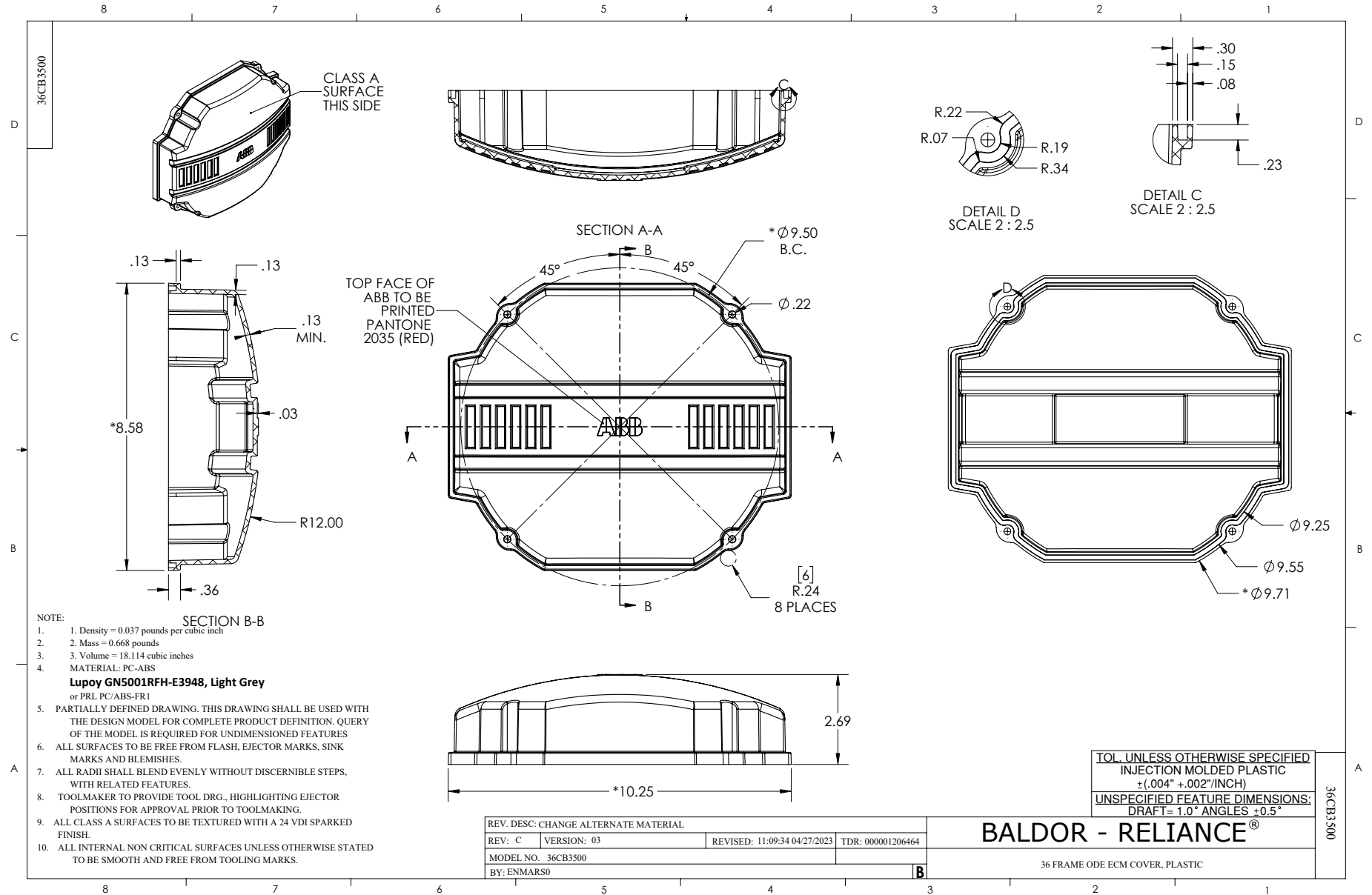

CD0006B03

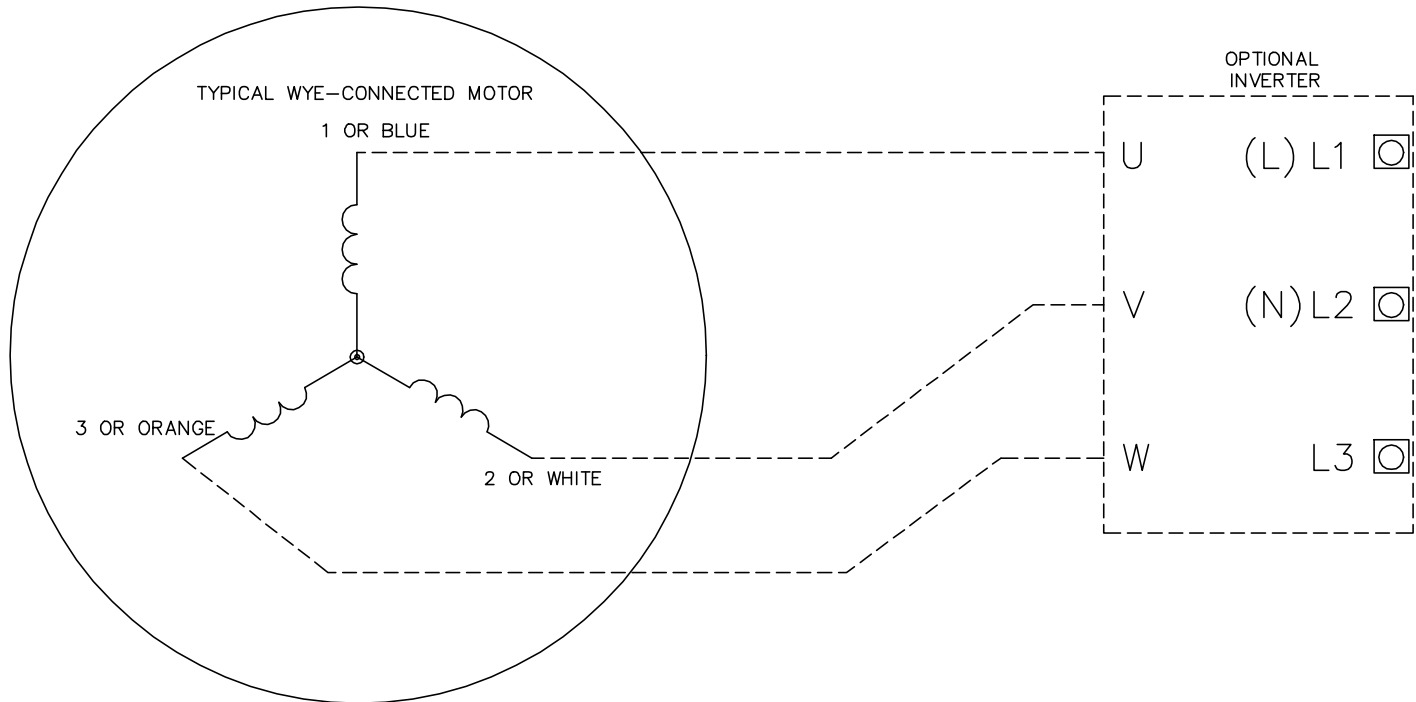

NOTES:

1. INTERCHANGE ANY TWO LINE LEADS TO REVERSE ROTATION.
2. ACTUAL NUMBER OF INTERNAL PARALLEL CIRCUITS MAY VARY.

CD0006B03

REV. DESC: CHANGE LEAD COLORS TO BLUE WHITE ORANGE		
REV. LTR: A	VERSION: 01	TDR: 000001158598
FILE: \AAA\00252\917	REVISED: 11:01:03 01/19/2021	BY: ENMARSO
MTL: -	© □	

BALDOR - RELIANCE®

3PH, SV, 3 LEADS, WYE CONNECTED, ECS

SH 1 of 1