

**BALDOR® • RELIANCE™**

---

# Customer information packet

## D5060RS-BV

60HP, 1750RPM, DC, 2812ATZ, DPG-FV,

**Specifications**

<b>Enclosure</b>	DP
<b>Frame</b>	MC2812ATZ
<b>Frame Material</b>	Steel
<b>Output Power</b>	60.000 HP
<b>Agency Approvals</b>	CCSA US
<b>Ambient Temperature</b>	40 °C
<b>Bearing Grease Type</b>	Polyrex EM (-20F +300F)
<b>Drip Cover</b>	No Drip Cover
<b>Feedback Device</b>	NO FEEDBACK
<b>Field Winding Type</b>	STAB SHUNT
<b>Frame Prefix</b>	MC
<b>Heater Indicator</b>	No Heater
<b>Lifting Lugs</b>	Standard Lifting Lugs
<b>Motor Standards</b>	NEMA
<b>Mounting Arrangement</b>	F2
<b>Overall Length</b>	37.38 IN
<b>Shaft Extension Location</b>	Pulley End
<b>Shaft Ground Indicator</b>	No Shaft Grounding
<b>Shaft Slinger Indicator</b>	No Slinger

**Part detail**

<b>Revision</b>	-
<b>Type</b>	DC
<b>Mech. spec.</b>	
<b>Base</b>	
<b>Status</b>	PRD/A
<b>Elec. spec.</b>	G7693A A
<b>Layout</b>	609952-096
<b>Eff. date</b>	04-13-2015
<b>CD Diagram</b>	406770-001
<b>Poles</b>	00
<b>Leads</b>	
<b>Proprietary</b>	False
<b>Created date</b>	04-09-2015

**Nameplate**

**000613006LP**

<b>CAT.NO.</b>	D5060RS-BV	<b>SPEC NO.</b>	T28T1330		
<b>FR</b>	MC 2812ATZ	<b>HP</b>	60	<b>DUTY</b>	CONT
<b>ENCL.</b>	DP	<b>RPM</b>	1750/ 2100	<b>S.F.</b>	1.0
<b>ENCL MOD</b>	FORCE VENT	<b>VOLTS</b>	500	<b>INSUL</b>	F
<b>MAX SAFE SPEED</b>	4500	<b>AMPS</b>	100.00	<b>AMB.</b>	40
	<b>FIELD DATA</b>	<b>SER.NO.</b>			
<b>WINDING</b>	STAB SHUNT	<b>POWER CODE</b>	C		
<b>VOLTS</b>	300	<b>D.E. BRG.</b>	65BC03J30X		
<b>MAX AMPS @ 25 C</b>	3.43	<b>O.D.E. BRG.</b>	55BC02J30X		
<b>HOT AMPS</b>	2.41/ 1.90	<b>MIN. AMB.</b>	0	<b>TYPE</b>	TR
	BRUSH:419904051AD; AIR BAFFLED				

609952-096

### INDUSTRIAL DIRECT CURRENT MOTORS AND GENERATORS - RPM III

ENCLOSURE: DRIP-PROOF FULLY-GUARDED, SPLASHPROOF  
 COOLING: FORCE VENTILATED WITH INTEGRAL BLOWER AND MOTOR  
 AIR FILTERED-SPECIAL BAFFLE  
 MOUNTING: FOOT  
 METHOD OF DRIVE: COUPLED OR BELTED  
 ACCESSORIES: PROVISION FOR TACHOMETER MOUNTING ONLY WHEN SPECIFIED  
 FRAMES SC2113ATZ THRU C2813ATZ

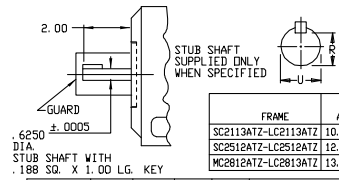
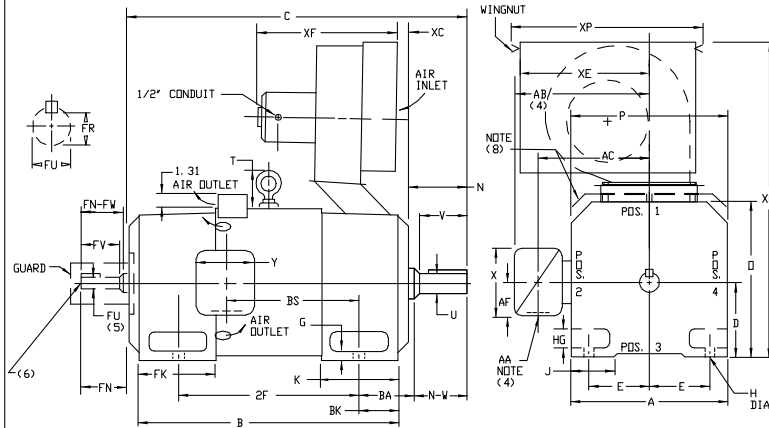

DIMENSIONS ARE IN INCHES

FRAME	XC	XE	XF	XD	XP
SC2113ATZ-LC2113ATZ	1.00	10.00	17.25	28.00	14.50
SC2512ATZ-LC2512ATZ	2.50	10.00	17.25	30.31	14.50
MC2812ATZ-LC2813ATZ	1.75	10.00	18.50	30.62	14.50

FRAME	A	D(1)	E	G	H	HG	J	D	P	T	BA	K	FK	BK
SC2113ATZ-LC2113ATZ	10.25	5.25	4.25	.44	1.44	1.38	1.75	10.44	10.31	2.56	3.50	5.19	6.81	2.38
SC2512ATZ-LC2512ATZ	12.31	6.25	5.00	.50	.56	1.62	2.00	12.50	12.44	3.06	4.25	6.06	8.00	3.00
MC2812ATZ-LC2813ATZ	13.78	7.00	5.50	.62	.56	1.88	2.75	14.00	13.94	3.38	4.75	6.75	9.19	3.50

FRAME	C	B	BS	2F	DRIVE END SHAFT AND KEY					OPPOSITE DRIVE END SHAFT AND KEY(S)					WT. LBS.				
					N	N-W	U(2)	V	R(3)	SQ	LGTH.	FN	FN-FW	FU(2)		FV	FR(3)	SQ	LGTH.
SC2113ATZ	28.38	22.50	1.38	18.00	4.00	3.75	1.875	3.50	1.391	500	2.50	3.50	3.25	1.625	3.00	1.416	375	2.25	345
MC2113ATZ	29.62	23.75	12.62	18.00	4.00	3.75	1.875	3.50	1.391	500	2.50	3.50	3.25	1.625	3.00	1.416	375	2.25	370
LC2113ATZ	31.25	25.38	14.25	18.00	4.00	3.75	1.875	3.50	1.391	500	2.50	3.50	3.25	1.625	3.00	1.416	375	2.25	400
SC2512ATZ	31.69	25.06	12.06	20.00	4.50	4.25	2.125	4.00	1.845	500	3.00	4.00	3.75	1.875	3.50	1.591	500	2.50	535
MC2512ATZ	33.19	26.56	13.56	20.00	4.50	4.25	2.125	4.00	1.845	500	3.00	4.00	3.75	1.875	3.50	1.591	500	2.50	570
LC2512ATZ	34.69	28.06	15.06	20.00	4.50	4.25	2.125	4.00	1.845	500	3.00	4.00	3.75	1.875	3.50	1.591	500	2.50	610
MC2812ATZ	37.38	29.94	14.25	22.00	5.00	4.75	2.375	4.50	2.021	625	3.50	4.50	4.25	2.125	4.00	1.845	500	3.00	810
LC2812ATZ	39.62	32.19	16.50	22.00	5.00	4.75	2.375	4.50	2.021	625	3.50	4.50	4.25	2.125	4.00	1.845	500	3.00	885
LC2813ATZ	41.25	33.81	18.12	25.00	5.00	4.75	2.375	4.50	2.021	625	3.50	4.50	4.25	2.125	4.00	1.845	500	3.00	940

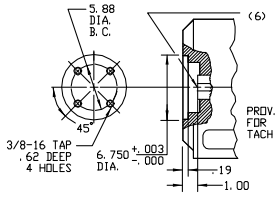

- (1) "B" DIMENSION WILL NOT BE EXCEEDED. SHIMS UP TO .03 INCHES IN THICKNESS ARE USUALLY REQUIRED FOR COUPLED OR GEARED MACHINES.
  - (2) "U" AND "FU" VARY-----, ODD -.001.
  - (3) "R" AND "FR" VARY-----, ODD -.015
  - (4) TERMINAL BOX VARIES WITH H.P. FOR DIMENSIONS "AA", "AB", "AC", "AF", "X" AND "Y". REFER TO BOX D/S. (STD. 609959-1, "X/P" 609959-2, MILL 609959-3)
  - (5) OPPOSITE DRIVE END SHAFT SUPPLIED ONLY WHEN SPECIFIED.
  - (6) MOTOR SHAFT TAPPED FOR SCREW-IN STUB SHAFT.
  - (7) WHEN THE MOTOR APPLICATION DOES NOT REQUIRE THE USE OF DPP, DRIVE END, ADD .25 TO "C" DIM. FOR BRACKET COVER.
  - (8) FOR HORIZONTAL APPLICATIONS ONLY.
- TERMINAL BOX CAN BE ROTATED FOR LEAD OUTLET AT TOP, SIDES OR BOTTOM. TERMINAL BOX LOCATED ON OPPOSITE SIDE WHEN F-2, W-1, V-4, V-5, V-7, OR C-1 MOUNTING IS SPECIFIED. BOX LOCATED ON TOP WHEN SPECIFIED. BLOWER ASSEMBLY CAN BE LOCATED AT POSITIONS 1, 2, OR 4. MOTOR WEIGHT MAY VARY 15% FOR NON-STANDARD RATINGS AND/OR ACCESSORIES. IF MOUNTING CLEARANCE DETAILS ARE REQUIRED, CONSULT FACTORY. BLOWER MOTOR

CUSTOMER IS RESPONSIBLE FOR DETERMINING THAT BALDOR'S PRODUCT WILL PERFORM SUITABLY IN THE INTENDED APPLICATION.

REV. DESC: UPDATE FRAME SIZE	VERSION: 01	TDR: 000000845571
REV. LTR: A	REVISED: 10:46:47 03/25/2014	BY: RCGWT
FILE: \\RGG\00015\585		
MTL: -		

**BALDOR**

DIMENSION DRAWING, SC2113ATZ - C2813ATZ, DPP, FOOT MTG.

SH 1 of 1

609952-096

609959-001

INDUSTRIAL DIRECT CURRENT MOTORS  
AND GENERATORS - RPM III  
STANDARD SIZE AND ONE SIZE LARGER  
TERMINAL BOX DIMENSIONS  
FRAMES C2113ATZ THRU C2815ATZ

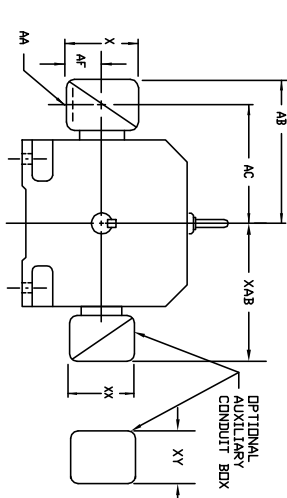
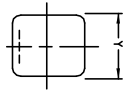

DIMENSIONS ARE IN INCHES

FRAME SIZE	MAX. AMPS	STANDARD SIZE						STEEL TERMINAL BOX DIMENSIONS						ONE SIZE LARGER										
		AK(1)	AB	AC	AF	X	Y	PART NUMBER	AK(1)	AB	AC	AF	X	Y	PART NUMBER	AK(1)	AB	AC	AF	X	Y	PART NUMBER		
C2113ATZ	40	3/4 & 1"	8.97	7.47	1.94	4.38	5.00	705028-1-R	1-1/4 & 1-1/2	10.03	8.03	2.50	3.50	6.12	705029-1-R									
C2115ATZ	96	1-1/4 & 1-1/2	10.03	8.03	2.50	5.50	6.12	705029-1-R	2" & 2-1/2	11.16	8.41	3.19	7.00	7.62	705030-1-R									
C2117ATZ	208	2" & 2-1/2	11.16	8.41	3.19	7.00	7.62	705030-1-R	2" & 2-1/2	11.16	8.41	3.19	7.00	7.62	705030-1-R									
C2513ATZ	40	3/4 & 1"	10.03	8.53	1.94	4.38	5.00	705029-1-R	1-1/4 & 1-1/2	11.09	9.09	2.50	5.50	6.12	705029-1-R									
C2515ATZ	96	1-1/4 & 1-1/2	11.09	9.09	2.50	5.50	6.12	705029-1-R	2" & 2-1/2	12.22	9.47	3.19	7.00	7.62	705030-1-R									
C2517ATZ	208	2" & 2-1/2	12.22	9.47	3.19	7.00	7.62	705030-1-R	2" & 2-1/2	12.22	9.47	3.19	7.00	7.62	705030-1-R									
C2813ATZ	188	2"	14.03	10.53	4.25	8.44	7.25	7487-4-R	3"	14.47	11.22	4.25	8.44	7.25	7487-4-R									
C2815ATZ	188	3"	14.47	11.22	4.25	8.44	7.25	7487-4-R	3"	15.91	11.84	5.38	10.56	9.00	706308-3-R									
C2817ATZ	259	4"	15.91	11.84	5.38	10.56	9.00	706308-3-R	5" (4)	18.59	13.34	7.00	12.75	15.00	706589-1-C									

FRAME SIZE	MAX. AMPS	STANDARD SIZE						CAST IRON TERMINAL BOX DIMENSIONS						ONE SIZE LARGER										
		AK(3)	AB	AC	AF	X	Y	PART NUMBER	AK(3)	AB	AC	AF	X	Y	PART NUMBER	AK(3)	AB	AC	AF	X	Y	PART NUMBER		
C2113ATZ	18	3/4	10.03	8.03	2.50	5.00	5.75	705028-2-S	1"	10.03	8.03	2.50	5.00	5.75	705028-2-T									
C2115ATZ	40	1"	10.03	8.03	2.50	5.00	5.75	705028-2-T	1-1/2	10.97	8.53	3.00	6.00	7.00	705029-2-S									
C2117ATZ	96	1-1/2	10.97	8.53	3.00	6.00	7.00	705029-2-S	2"	10.97	8.53	3.00	6.00	7.00	705029-2-S									
C2513ATZ	18	3/4	11.09	9.09	2.50	5.00	5.75	705028-2-S	1"	11.09	9.09	2.50	5.00	5.75	705028-2-T									
C2515ATZ	40	1-1/2	12.03	9.59	3.00	6.00	7.00	705029-2-R	2"	12.03	9.59	3.00	6.00	7.00	705029-2-S									
C2517ATZ	208	2"	12.78	10.34	3.00	6.00	7.00	75460-T	3"	13.72	9.97	3.62	7.88	9.25	705030-2-S									
C2813ATZ	188	3"	14.47	10.72	3.62	7.88	9.25	76700-4R	4"	14.47	10.72	3.62	7.88	9.25	76700-4R									
C2815ATZ	188	4"	15.78	11.59	4.12	9.50	10.50	76708-RR	5" (4)	15.78	11.59	4.12	9.50	10.50	76708-RR									

FRAME SIZE	AMPS	STANDARD SIZE						OPTIONAL AUXILIARY CONDUIT BOX DIMENSIONS (IEC TYPE BOX)							
		AB	AC	AF	X	AA	Y	PART NUMBER	AB	AC	AF	X	AA	Y	PART NUMBER
C210	100	10.71	8.98	2.72	7.48	---	7.48	706310-25-A	10.88	9.15	2.89	7.81	---	7.81	706310-25-R
	200	11.66	9.25	3.35	8.82	---	8.82	706310-56-A	11.84	9.52	3.52	9.15	---	9.15	706310-56-R
	400	11.30	9.57	2.72	7.48	---	7.48	706310-56-B	11.30	9.57	2.72	7.48	---	7.48	706310-56-C
C250	200	11.85	9.84	3.35	8.82	---	8.82	706310-56-B	11.85	9.84	3.35	8.82	---	8.82	706310-56-C
	400	17.48	12.75	6.20	14.39	---	14.39	706310-63-B & 706310-63C	17.48	12.75	6.20	14.39	---	14.39	706310-63-B & 706310-63C
	800	17.48	12.75	6.20	14.39	---	14.39	706310-63-B & 706310-63C	17.48	12.75	6.20	14.39	---	14.39	706310-63-B & 706310-63C
C280	200	12.60	10.59	3.76	8.82	---	8.82	706310-56-B	12.60	10.59	3.76	8.82	---	8.82	706310-56-C
	400	18.27	13.54	6.20	14.39	---	14.39	706310-63-B & 706310-63C	18.27	13.54	6.20	14.39	---	14.39	706310-63-B & 706310-63C
	800	18.27	13.54	6.20	14.39	---	14.39	706310-63-B & 706310-63C	18.27	13.54	6.20	14.39	---	14.39	706310-63-B & 706310-63C
	1600	18.27	13.54	7.68	15.35	---	15.35	706310-63-C	18.27	13.54	7.68	15.35	---	15.35	706310-63-C

- (1) MAX. CONDUIT
- (2) FRAME TERMINAL BOX FOR C2113ATZ AND C2513ATZ
- (3) FRAME TERMINAL BOX WITH MODULE KNOWNDON
- (4) TERMINAL BOX 76970-S AND 76970-R EXTENDS BELOW MOTOR FEET

CUSTOMER IS RESPONSIBLE FOR DETERMINING THAT BALDOR'S PRODUCT WILL PERFORM SUITABLY IN THE INTENDED APPLICATION.

REV. DESC: ADD 706310-63G C/BOX TO C250 AND C280 FRAMES	VERSION: 01	TDR: 00000816512
REV. LTR: A		
FILE: \RGG\00021\153		REVISED: 03: 09: 09 09/06/2013
MTL: -		BY: RGGWT



DIMENSION SHEET  
SH 1 of 1

609959-001

065564-004

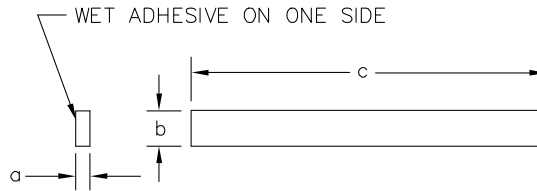

SYM	MAKE FROM 065564-004	a	b	c	REMARKS
A	X	1/8	5/8	24*	TERMBOX & CVR 180AT-250AT
B	X	1/8	5/8	37 1/2*	TERMBOX & CVR 280AT-320AT
C	Y	1/4	5/8	44 1/2 $\Delta$	FILTER TO HOUSING GASKET
D	X	1/8	5/8	170"	TEAO HEAT EXCH.
E	Y	1/4	5/8	72" $\Delta$	TERMBOX & CVR

SYM	MAT'L SPEC	a	b	c
X	46024-XV	1/8	5/8	* 50' ROLL; WET ADHESIVE ON ONE SIDE
Y	46024-XV	1/4	5/8	* 50' ROLL; WET ADHESIVE ON ONE SIDE

$\Delta$  RELIANCE WILL CUT AND MOUNT ON FILTER HOUSING PER ASSEMBLY DRAWING 603989-2.

\* PROD. NOTE: WHEN ORDERING THRU PURCHASING ORDER AS 50 FT. ROLLS, WET ADHESIVE ON ONE SIDE. RELIANCE WILL CUT AND MOUNT ON COVER. PER INSTRUCTIONS ON COVER DRAWINGS.

CUSTOMER IS RESPONSIBLE FOR DETERMINING THAT BALDOR'S PRODUCT WILL PERFORM SUITABLY IN THE INTENDED APPLICATION.

REV. DESC: CHANGE DESCRIPTION ON TITLE BLOCK		
REV. LTR: C	VERSION: 03	TDR: 00000571980
FILE: \RGG\00000\220	REVISED: 10:54:04 12/16/2010	BY: RGGWT
MTL: -		

**BALDOR**  
GASKET,STRIP,CLOSED CELL NEOPRENE  
SH 1 of 1

065564-004

406770-001

406770-001

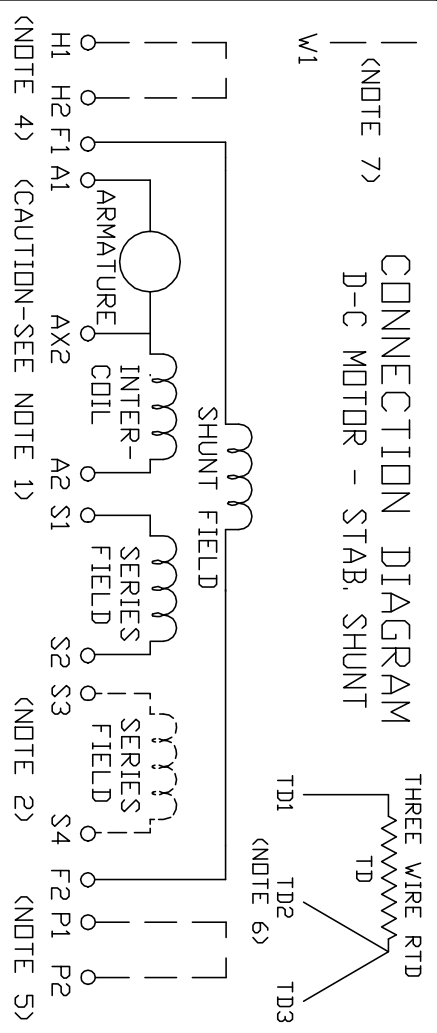

ARMATURE AND FIELD EXTERNAL CONNECTIONS  
WARNING- SEE NOTE 8 FOR GROUNDING INSTRUCTIONS



ROTATION FACING COMMUTATOR END

1. CAUTION — ARMATURE AND SERIES FIELD MAY HAVE MULTIPLE LEADS. CONNECT ALL LUGS WITH THE SAME MARKING TOGETHER.
2. OPTIONAL SERIES FIELD IS MARKED S3 AND S4. FOR CUMULATIVE SERIES FIELD, CONNECT S3 TO S2 AND CONNECT S4 TO NEGATIVE. FOR DIFFERENTIAL SERIES FIELD CONNECT S4 TO S2 AND S3 TO NEGATIVE.
3. OPTIONAL CONTROL SIGNAL LEAD IS MARKED AX2. ALWAYS TAKE INTERPOLE DROP BETWEEN A2 AND AX2. NOTE: NEMA DESIGNATION FOR AX2 IS LETTER C.
4. SPACE HEATERS, WHEN PROVIDED, WILL HAVE LEADS MARKED H1 AND H2, H3, H4, ETC.
5. THERMAL PROTECTOR, WHEN PROVIDED, WILL HAVE LEADS MARKED P1 AND P2, P3, P4, ETC.
6. WINDING RTD'S, WHEN PROVIDED, WILL HAVE LEADS MARKED TD1, TD2, & TD3
7. BRUSH WEAR SENSOR, WHEN PROVIDED, WILL HAVE LEAD MARKED W1.
8. WARNING — MOTOR MUST BE GROUNDED TO PREVENT SERIOUS INJURIES TO PERSONNEL. GROUND THE MOTOR PER IEC, NATIONAL ELECTRICAL CODE AND ANY APPLICABLE LOCAL ELECTRICAL CODES. A TAPPED HOLE IS PROVIDED IN THE CONDUIT BOX, ON THE FOOT, FRAME BRACE OR OPPOSITE DRIVE END BRACKET, ADJACENT TO THE TERMINAL BOX FOR MOTOR GROUNDING. GROUND LEAD, WHEN PROVIDED, WILL BE GREEN.

CUSTOMER \_\_\_\_\_ ORDER NO. \_\_\_\_\_ S.D. NO. \_\_\_\_\_

REV. DESC: DELETED DUPLICATE WORDS FROM NOTE 8

REV. LTR: A

VERSION: 01

TDR: 000000970330

FILE: \RSN\00026\422

REVISED: 10:19:12 03/11/2016

BY: RAGTBM

MTL: -

**BALDOR**

D-C MOTOR CONNECTION DIAGRAM STAB. SHUNT

SH 1 of 1