

**BALDOR • RELIANCE**

---

# Customer information packet

## CPX36746T

75//60HP, 1780//1480RPM, 3PH, 60//50HZ, 365T

Class - CLI GP C,D; CLII GP E,F,G

Division - Division I

## Specifications

Enclosure	TEFC
Frame	365T
Frame Material	Iron
Frequency	60.00 Hz
Haz Area Class and Group	CLI GP C,D; CLII GP E,F,G
Haz Area Division	Division I
Motor Letter Type	Three Phase
Output @ Frequency	75.000 HP @ 60 HZ
Phase	3
Synchronous Speed @ Frequency	1800 RPM @ 60 HZ
Voltage @ Frequency	230.0 V @ 60 HZ 460.0 V @ 60 HZ
Agency Approvals	CCSAUSEEV CSA UL
Ambient Temperature	40 °C
Auxillary Box	No Auxillary Box
Base Indicator	Rigid
Bearing Grease Type	Polyrex EM (-20F +300F)
Constant Torque Speed Range	10-60
Current @ Voltage	86.000 A @ 460.0 V 172.000 A @ 230.0 V
Design Code	B
Drip Cover	No Drip Cover
Duty Rating	CONT
Efficiency @ 100% Load	95.4 %
Enclosure Modification	Severe Duty Features
Feedback Device	NO FEEDBACK
Haz Area Temp Code	T3C
Heater Indicator	No Heater
High Voltage Full Load Amps	86.0 a
Insulation Class	F

## Part detail

Revision	F
Type	AC
Mech. spec.	
Base	
Status	PRD/A
Elec. spec.	A36WG1512
Layout	616512-505
Eff. date	05-06-2024
CD Diagram	416820-002
Poles	04
Leads	3#4,6#6
Proprietary	False
Created date	02-07-2019

<b>Inverter Code</b>	Inverter Ready
<b>IP Rating</b>	IP55
<b>KVA Code</b>	G
<b>Lifting Lugs</b>	Standard Lifting Lugs
<b>Max Speed</b>	3600 rpm
<b>Motor Lead Quantity/Wire Size</b>	3 @ 4 AWG
<b>Motor Standards</b>	NEMA
<b>Motor Type</b>	A36070M
<b>Mounting Arrangement</b>	F1
<b>Number of Poles</b>	4
<b>Overall Length</b>	33.48 IN
<b>Power Factor</b>	86
<b>Product Family</b>	General Industrial
<b>Pulley End Bearing Type</b>	Ball
<b>Pulley Face Code</b>	Standard
<b>Service Factor</b>	1.15
<b>Shaft Diameter</b>	2.374 IN
<b>Shaft Ground Indicator</b>	No Shaft Grounding
<b>Shaft Rotation</b>	Reversible
<b>Shaft Slinger Indicator</b>	Shaft Slinger
<b>Speed</b>	1780 rpm
<b>Speed Code</b>	Single Speed
<b>Starting Method</b>	Direct on line
<b>Thermal Device - Bearing</b>	None
<b>Thermal Device - Winding</b>	Normally Closed Thermostat

**Nameplate**

---

NP2496L	
MOBIL POLYREX EM	

---

---

**000613006PC**

---

**CLASS I GROUP** C D X **NO.****CLASS II GROUP** E F G**OPERATING TEMP CODE** T3C

---

---

**000901002AAA**

---

SUIT @ 55C AMB AT 1.00 SF AT S	INEWAVE

**NP3140L**

<b>SPEC NO.</b>	A36-7732-1512	<b>CAT.NO.</b>	CPX36746T	<b>FRAME</b>	365T
<b>HP</b>	75	<b>VOLTS</b>	230/460	<b>PHASE</b>	3
<b>RPM</b>	1780	<b>AMPS</b>	172/86	<b>HZ</b>	60
<b>DRIVE END BEARING</b>	65BC03J30X	<b>DUTY</b>	CONT	<b>INSUL.CLASS</b>	F
<b>OPP D.E. BEARING</b>	65BC03J30X	<b>ENCL</b>	TEFC	<b>CODE</b>	G
<b>SF</b>	1.15	<b>WK2</b>	14.02	<b>MAG CUR</b>	27.6
<b>CT HZ</b>	10-60	<b>VT HZ</b>	0-60	<b>CHP HZ</b>	60-90
	IP66			<b>RPM MAX</b>	3600
<b>SER.NO.</b>		<b>MOTOR WEIGHT</b>		<b>NEMA-NOM-EFF</b>	95.4









**DUTY MASTER ALTERNATING CURRENT MOTORS**

616512-505

SQUIRREL-CAGE INDUCTION

ENCLOSURE: TOTALLY ENCLOSED

FRAME 365T

COOLING: FAN-COOLED

MOUNTING: FOOT, F-1 SIDE

INCLUDES 364T FRAME MOUNTING HOLES  
CLASS 1 GROUP C&D / CLASS 2 GROUP E,F & G  
WITH TACONITE SEAL BOTH ENDS

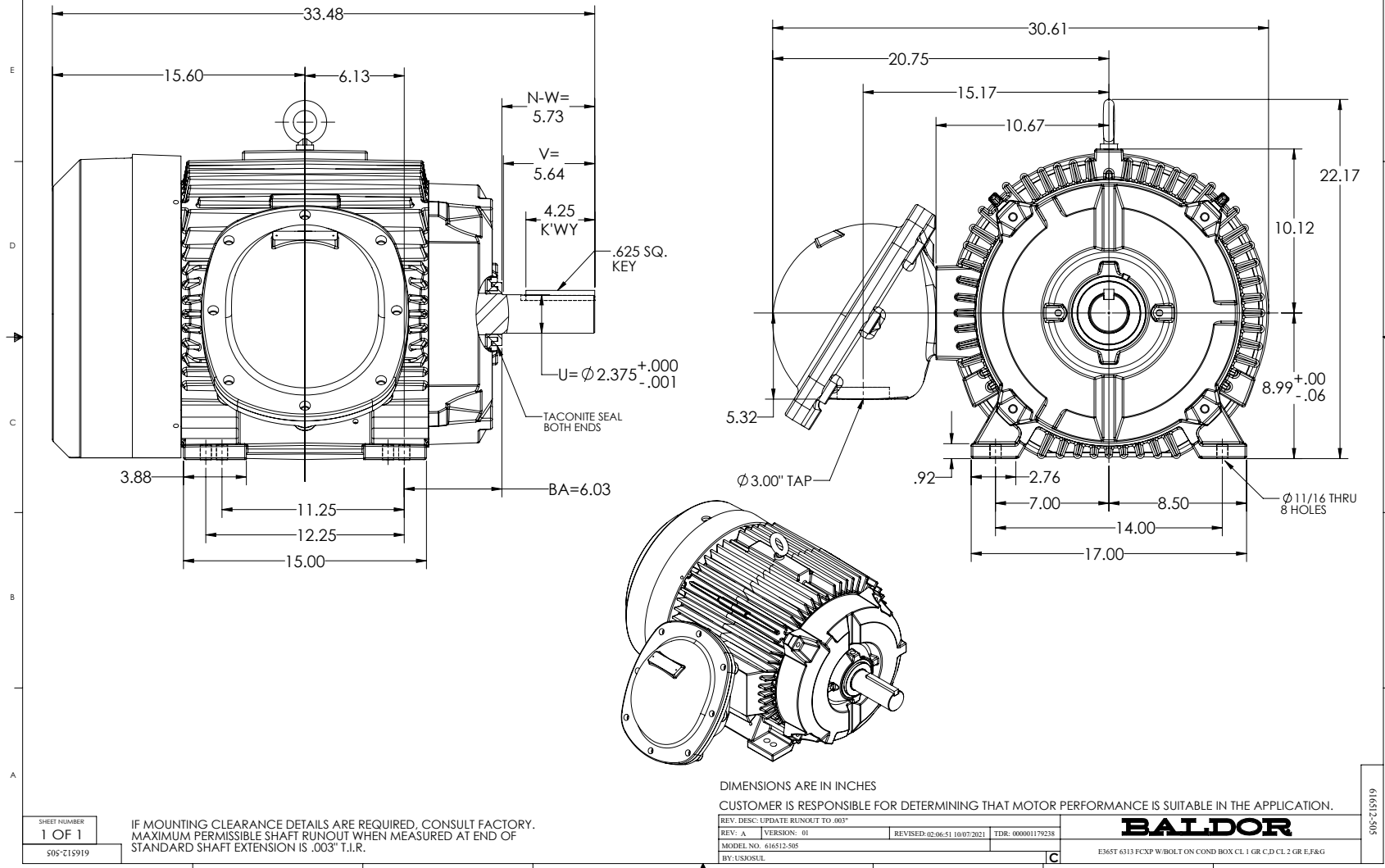

DIMENSIONS ARE IN INCHES

CUSTOMER IS RESPONSIBLE FOR DETERMINING THAT MOTOR PERFORMANCE IS SUITABLE IN THE APPLICATION.

REV. DESC: UPDATE RUNOUT TO .003"

REV: A | VERSION: 01 | REVISED: 02-06-51 10/07/2021 | TDR: 00000179238

MODEL NO. 616512-505

BY: USRSUL

**BALDOR**

E365T 6313 FCXP W/BOLT ON COND BOX CL 1 GR. C,D CL 2 GR. E,F&G

SHEET NUMBER  
1 OF 1

S05-215919

IF MOUNTING CLEARANCE DETAILS ARE REQUIRED, CONSULT FACTORY.  
MAXIMUM PERMISSIBLE SHAFT RUNOUT WHEN MEASURED AT END OF  
STANDARD SHAFT EXTENSION IS .003" T.I.R.

616512-505

# CONNECTION DIAGRAM ACCESSORIES

MOTOR WINDING THERMOSTATS	
CONTACTS _____ @ _____ °C	
FIGURE NUMBER _____	
CONTACT RATING	
VOLTS	CONTINUOUS AMPERES
110-120	3.0
220-240	1.5
440-480	0.75
550-600	0.60
	INRUSH AMPERES
	30
	15
	7.5
	6.0

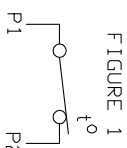
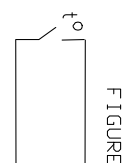
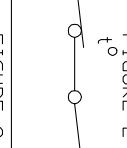
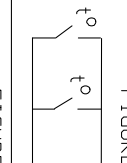
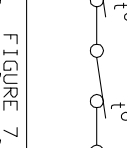
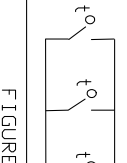
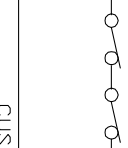
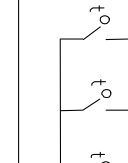
NORMALLY CLOSED	THERMOSTATS	NORMALLY OPEN
 <p>FIGURE 1</p>		 <p>FIGURE 4</p>
 <p>FIGURE 2</p>		 <p>FIGURE 5</p>
 <p>FIGURE 3</p>		 <p>FIGURE 6</p>
 <p>FIGURE 7</p>		 <p>FIGURE 8</p>

CUSTOMER \_\_\_\_\_ CUSTOMER ORDER NO. \_\_\_\_\_ S.O. NO. \_\_\_\_\_

418174-006

418174-006

REV. DESC: LOADED TO BUS		
REV. LTR: A	VERSION: 01	TDR: 000000570390
FILE: \RAG\00013\849	REVISED: 10:16:21 12/07/2010	BY: RAGDRF
MTL: -		

**BALDOR**

A-C MOTOR CONNECTION ACCESSORIES

SH 1 of 1

416820-002

A-C MOTOR  
 CONNECTION DIAGRAM  
 STANDARD 9 LEAD DELTA-CONNECTED

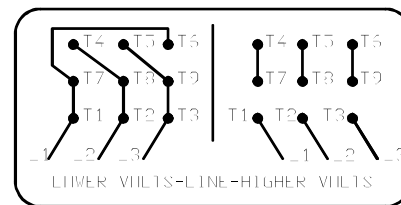
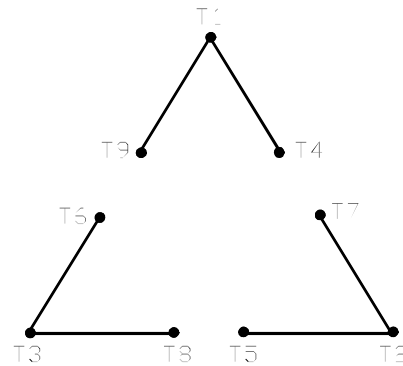

(N.P. 1575-B)

416820-002

REV. DESC: FONT CHANGE FOR PDF SEARCHABLE		
REV. LTR: A	VERSION: 01	TDR: 000001009382
FILE: \MGA\00000\661	REVISED: 02:46:19 02/13/2020	BY: MGHMTT
MTL: -	© □	

**BALDOR - RELIANCE®**

CONN DIAG - STANDARD 9 LEAD, DELTA-CONNECTED

SH 1 of 1