

BALDOR • RELIANCE

Customer information packet

CPX36726T

75HP, 3555RPM, 3PH, 60HZ, 365TS, TEFC, F1

Class - CLI GP C,D; CLII GP E,F,G

Division - Division I

Specifications

Enclosure	TEFC
Frame	365TS
Frame Material	Iron
Frequency	60.00 Hz
Haz Area Class and Group	CLI GP C,D; CLII GP E,F,G
Haz Area Division	Division I
Motor Letter Type	Three Phase
Output @ Frequency	75.000 HP @ 60 HZ
Phase	3
Synchronous Speed @ Frequency	3600 RPM @ 60 HZ
Voltage @ Frequency	230.0 V @ 60 HZ 460.0 V @ 60 HZ
Agency Approvals	CCSAUSEEV CSA UL
Ambient Temperature	40 °C
Auxillary Box	No Auxillary Box
Base Indicator	Rigid
Bearing Grease Type	Polyrex EM (-20F +300F)
Constant Torque Speed Range	6-60
Current @ Voltage	81.800 A @ 460.0 V 164.000 A @ 230.0 V
Design Code	B
Drip Cover	No Drip Cover
Duty Rating	CONT
Efficiency @ 100% Load	93.6 %
Enclosure Modification	Severe Duty Features
Feedback Device	NO FEEDBACK
Haz Area Temp Code	T3C
Heater Indicator	No Heater
High Voltage Full Load Amps	81.8 a
Insulation Class	F

Part detail

Revision	-
Type	AC
Mech. spec.	
Base	
Status	PRD/A
Elec. spec.	A36WG0026
Layout	617428-706
Eff. date	05-01-2019
CD Diagram	416820-002
Poles	02
Leads	3#2,6#4
Proprietary	False
Created date	04-26-2019

Inverter Code	Inverter Ready
IP Rating	IP55
KVA Code	F
Lifting Lugs	Standard Lifting Lugs
Max Speed	4200 rpm
Motor Lead Quantity/Wire Size	3 @ 2 AWG
Motor Standards	NEMA
Motor Type	A36068M
Mounting Arrangement	F1
Number of Poles	2
Overall Length	31.35 IN
Power Factor	92
Product Family	General Industrial
Pulley End Bearing Type	Ball
Pulley Face Code	Standard
Service Factor	1.00
Shaft Diameter	1.875 IN
Shaft Ground Indicator	No Shaft Grounding
Shaft Rotation	Reversible
Shaft Slinger Indicator	Shaft Slinger
Speed	3555 rpm
Speed Code	Single Speed
Starting Method	Direct on line
Thermal Device - Bearing	None
Thermal Device - Winding	Normally Closed Thermostat

Nameplate

NP2496L	
MOBIL POLYREX EM	

000692000FX



000613006PC

CLASS I GROUP C D X **NO.****CLASS II GROUP** E F G**OPERATING TEMP CODE** T3C

000901002AAA

SUITABLE FOR 55C AMB AT 1.00 S

F AT SINEWAVE

NP3140L

SPEC NO.	A36-5003-0026		CAT.NO.	CPX36726T		FRAME	365TS
HP	75	VOLTS	230/460		PHASE	3	DESIGN B TYPE P
RPM	3555	AMPS	164/81.8		HZ	60	AMB 40 SF 1.00
DRIVE END BEARING	65BC03J30X		DUTY	CONT	INSUL.CLASS	F	
OPP D.E. BEARING	65BC03J30X		ENCL	TEFC	CODE	F	
SF	1.15	WK2	8.642	MAG CUR	31/15.5		RPM MAX 4200
CT HZ	6-60	VT HZ	0-60	CHP HZ	60-70		NEMA-NOM-EFF 93.6
	IP66						
SER.NO.			MOTOR WEIGHT	1005			

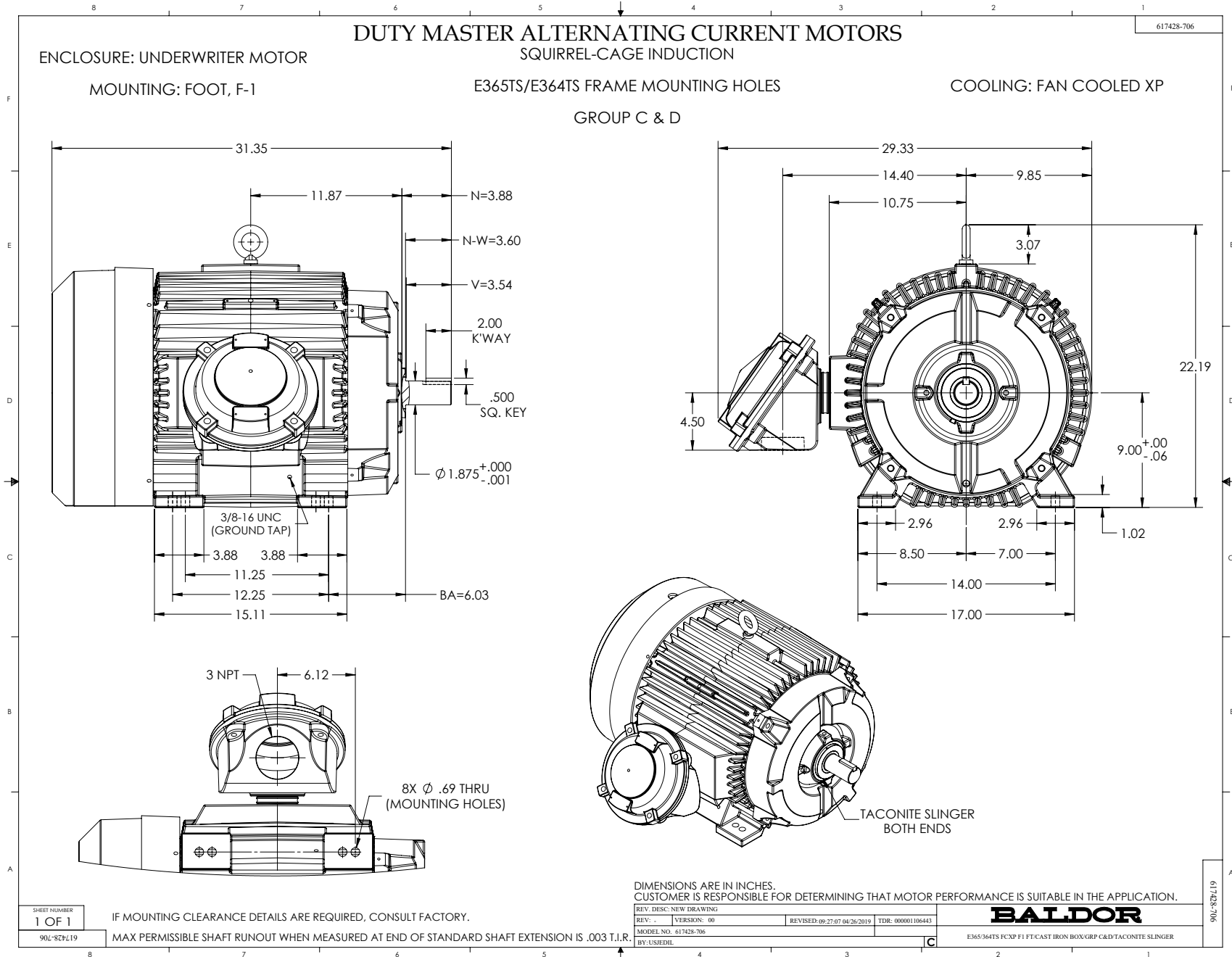

CONNECTION DIAGRAM ACCESSORIES

MOTOR WINDING THERMOSTATS	
CONTACTS _____ @ _____ °C	
FIGURE NUMBER _____	
CONTACT RATING	
VOLTS	CONTINUOUS AMPERES
110-120	3.0
220-240	1.5
440-480	0.75
550-600	0.60
	INRUSH AMPERES
	30
	15
	7.5
	6.0

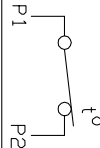
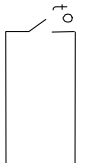
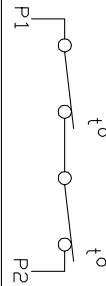
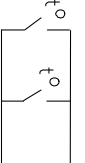
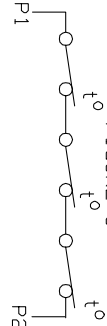
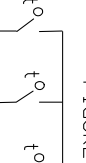
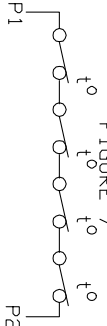
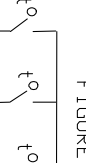
NORMALLY CLOSED	THERMOSTATS	NORMALLY OPEN
 FIGURE 1		 FIGURE 4
 FIGURE 2		 FIGURE 5
 FIGURE 3		 FIGURE 6
 FIGURE 7		 FIGURE 8

CUSTOMER _____ CUSTOMER ORDER NO. _____ S.O. NO. _____

418174-006

418174-006

REV. DESC: LOADED TO BUS		
REV. LTR: A	VERSION: 01	TDR: 000000570390
FILE: \RAG\00013\849	REVISED: 10:16:21 12/07/2010	BY: RAGDRF
MTL: -		

BALDOR

A-C MOTOR CONNECTION ACCESSORIES

SH 1 of 1

416820-002

A-C MOTOR
 CONNECTION DIAGRAM
 STANDARD 9 LEAD DELTA-CONNECTED

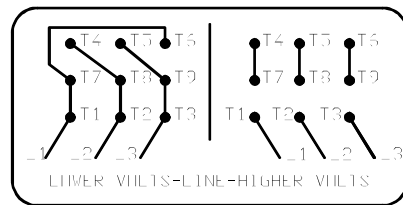
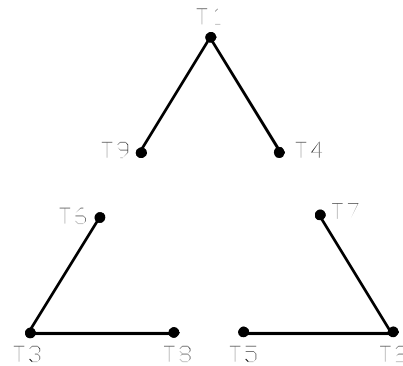

(N.P. 1575-B)

416820-002

REV. DESC: FONT CHANGE FOR PDF SEARCHABLE		
REV. LTR: A	VERSION: 01	TDR: 000001009382
FILE: \MGA\00000\661	REVISED: 02:46:19 02/13/2020	BY: MGHMTT
MTL: -		© □

BALDOR - RELIANCE®

CONN DIAG - STANDARD 9 LEAD, DELTA-CONNECTED

SH 1 of 1