



Brushless Servo Motors

Installation and Operating Manual

Table of Contents

Section 1

General Information	1-1
Overview	1-1
Limited Warranty	1-1
Safety Notice	1-2

Section 2

Installation	2-1
Overview	2-2
Location	2-2
Mounting	2-2
Alignment	2-2
Receiving	2-3
Storage	2-3
Unpacking	2-3
Handling	2-3
Repairs	2-3
Prevent Electrical Noise	2-3
Shaft Loads	2-4
Life Determination	2-6
Speed and Torque	2-8
Holding Brake	2-8
Electrical Connections	2-10
Overview	2-10
Motor Lead Termination	2-10
Feedback Termination	2-12
Feedback Devices	2-13
Brushless Servo Motor Identification	2-15

Section 1

General Information

Overview This manual contains general procedures that apply to Baldor Motor products. Be sure to read and understand the Safety Notice statements in this manual. For your protection, do not install, operate or attempt to perform maintenance procedures until you understand the Warning and Caution statements. A Warning statement indicates a possible unsafe condition that can cause harm to personnel. A Caution statement indicates a condition that can cause damage to equipment.

Important: **This instruction manual is not intended to include a comprehensive listing of all details for all procedures required for installation, operation and maintenance. This manual describes general guidelines that apply to most of the motor products shipped by Baldor. If you have a question about a procedure or are uncertain about any detail, Do Not Proceed. Please contact your Baldor distributor for more information or clarification.**

Before you install, operate or perform maintenance, become familiar with the following:

- NEMA Publication ICS16, Motion/Position Control Motors; Controls; and Feedback Devices.
- The National Electrical Code
- Local codes and Practices

Limited Warranty

1. Baldor Electric motors are warranted for a period of one (1) year, from date of shipment from the factory or factory warehouse against defects in material and workmanship. To allow for stocking and/or fabrication period and to provide one year of actual service, the warranty period is extended for an additional period of six (6) months for a total of eighteen (18) months from the original date of shipment from the factory or factory warehouse stock. In no case will the warranty period be extended for a longer period. Baldor extends this limited warranty to each buyer of the electric motor for the purpose of resale and to the original purchaser for use.
2. Baldor will, at its option repair or replace a motor which fails due to defects in material or workmanship during the warranty period if:
 - a. the purchaser presents the defective motor at or ships it prepaid to, the Baldor plant in Fort Smith, Arkansas or one of the Baldor Authorized Service Centers and
 - b. the purchaser gives written notification concerning the motor and the claimed defect including the date purchased, the task performed by the Baldor motor and the problem encountered.
3. Baldor will not pay the cost of removal of any electric motor from any equipment, the cost of delivery to Fort Smith, Arkansas or a Baldor Authorized Service Center, or the cost of any incidental or consequential damages resulting from the claimed defects. (Some states do not allow the exclusion or limitation of incidental or consequential damages, so the above exclusion may not apply to you.) Any implied warranty given by laws shall be limited to the duration of the warranty period hereunder. (Some states do not allow limitations on how long an implied warranty lasts, so the above limitation may not apply to you.)

-
4. Baldor Authorized Service Centers, when convinced to their satisfaction that a Baldor motor developed defects in material or workmanship within the warranty period, are authorized to proceed with the required repairs to fulfill Baldor's warranty when the cost of such repairs to be paid by Baldor does not exceed Baldor's warranty repair allowance. Baldor will not pay overtime premium repair charges without prior written authorization.
 5. The cost of warranty repairs made by centers other than Baldor Authorized Service Centers **WILL NOT** be paid unless first authorized in writing by Baldor.
 6. Claims by a purchaser that a motor is defective even when a failure results within one hour after being placed into service are not always justified. Therefore, Baldor Authorized Service Centers must determine from the condition of the motor as delivered to the center whether or not the motor is defective. If in the opinion of a Baldor Authorized Service Center, a motor did not fail as a result of defects in material or workmanship, the center is to proceed with repairs only if the purchaser agrees to pay for such repairs. If the decision is in dispute, the purchaser should still pay for the repairs and submit the paid invoice and the Authorized Service Center's signed service report to Baldor for further consideration.
 7. This warranty gives you specific legal rights, and you may also have other rights which vary from state to state.

Safety Notice: This equipment contains high voltage! Electrical shock can cause serious or fatal injury. Only qualified personnel should attempt installation, operation and maintenance of electrical equipment.

Be sure that you are completely familiar with NEMA publications ICS16 and MG-2, safety standards for construction and guide for selection, installation and use of electric motors and generators, the National Electrical Code and local codes and practices. Unsafe installation or use can cause conditions that lead to serious or fatal injury. Only qualified personnel should attempt the installation, operation and maintenance of this equipment.

WARNING: Do not use these motors in the presence of flammable or combustible vapors or dust. These motors are not designed for atmospheric conditions that require explosion proof construction.

WARNING: Do not touch electrical connections before you first ensure that power has been disconnected. Electrical shock can cause serious or fatal injury. Only qualified personnel should attempt the installation, operation and maintenance of this equipment.

WARNING: Be sure the system is properly grounded before applying power. Do not apply power before you ensure that all grounding instructions have been followed. Electrical shock can cause serious or fatal injury. National Electrical Code and Local codes must be carefully followed.

WARNING: Avoid extended exposure to machinery with high noise levels. Be sure to wear ear protective devices to reduce harmful effects to your hearing.

-
- WARNING:** The holding brake alone does not guaranty personnel safety. Use structural measures such as protective fences or a second brake to secure personnel safety.
- WARNING:** This equipment may be connected to other machinery that has rotating parts or parts that are driven by this equipment. Improper use can cause serious or fatal injury. Only qualified personnel should attempt to install operate or maintain this equipment.
- WARNING:** Do not by-pass or disable protective devices or safety guards. Safety features are designed to prevent damage to personnel or equipment. These devices can only provide protection if they remain operative.
- WARNING:** Avoid the use of automatic reset devices if the automatic restarting of equipment can be hazardous to personnel or equipment.
- WARNING:** Be sure the load is properly coupled to the motor shaft before applying power. The shaft key must be fully captive by the load device. Improper coupling can cause harm to personnel or equipment if the load decouples from the shaft during operation.
- WARNING:** Use proper care and procedures that are safe during handling, lifting, installing, operating and maintaining operations. Improper methods may cause muscle strain or other harm.
- WARNING:** Before performing any motor maintenance procedure, be sure that the equipment connected to the motor shaft cannot cause shaft rotation. If the load can cause shaft rotation, disconnect the load from the motor shaft before maintenance is performed. Unexpected mechanical rotation of the motor parts can cause injury or motor damage.
- WARNING:** Disconnect all electrical power from the motor windings and accessory devices before disassembly of the motor. Electrical shock can cause serious or fatal injury.
- WARNING:** Ensure all electrical connections are securely made. High voltage may be present and high motor speeds may result from a broken connection.
- WARNING:** Pacemaker Danger – Magnetic and electromagnetic fields in the vicinity of current carrying conductors and permanent magnet motors can result in a serious health hazard to persons with cardiac pacemakers, metal implants and hearing aids.
- WARNING:** Dangerous movements can occur when a motor is improperly connected or a fault occurs. Be careful during start-up, troubleshooting and maintenance procedures to avoid injury.
- WARNING:** Severe burn is possible. The motor winding can reach 155 degrees C during operation. Do not touch motor without protective clothing or allow sufficient time for motor to cool to avoid burns.

Safety Notice Continued

- Caution:** To prevent premature equipment failure or damage, only qualified maintenance personnel should perform maintenance.
- Caution:** Do not lift the motor and its driven load by the motor lifting hardware. The motor lifting hardware is adequate for lifting only the motor. Disconnect the load from the motor shaft before moving the motor.
- Caution:** To prevent equipment damage, be sure that the control is fused for the maximum motor rated amps listed on the rating plate.
- Caution:** If a HI POT test (High Potential Insulation test) must be performed, follow the precautions and procedure in NEMA MG-1 and MG-2 standards to avoid equipment damage.
- Caution:** Do not perform dielectric withstand tests on any feedback device or motor control as damage may result.
- Caution:** Motor housings get very hot during normal operation. Do not touch the motor after use until it has had sufficient time to cool. Severe burns may result from touching the motor after use.
- Caution:** Do not use the holding brake to stop motion. This will cause premature brake wear and failure. The brakes are not designed to stop a rotating load. The servo drive inputs should always be used to stop motor shaft rotation.
- Caution:** The AC servo motor is not intended to be connected directly to the AC mains. Do not connect AC Mains directly to BSM AC Servo Motors.

If you have any questions or are uncertain about any statement or procedure, or if you require additional information please contact your Baldor distributor or an Authorized Baldor Service Center.

Section 2 Installation

Overview Installation should conform to the National Electrical Code as well as local codes and practices. When other devices are coupled to the motor shaft, be sure to install protective devices to prevent accidents. Some protective devices include, coupling, belt guard, chain guard, shaft covers etc. These protect against accidental contact with moving parts. Machinery that is accessible to personnel should provide further protection in the form of guard rails, screening, warning signs etc.

Location The motor should be installed in an area that is protected from direct sunlight, corrosives, harmful gases or liquids, dust, metallic particles, and vibration. Exposure to these can reduce the operating life and degrade performance. Be sure to allow clearance for ventilation and access for cleaning, repair, service and inspections. Ventilation is extremely important. Be sure the area for ventilation is not obstructed. Obstructions will limit the free passage of air. Motors get warm and the heat must be dissipated to prevent damage. These motors are not designed for atmospheric conditions that require explosion proof operation. They must **NOT** be used in the presence of flammable or combustible vapors or dust.

Mounting The motor must be securely installed to a rigid foundation or mounting surface to minimize vibration and maintain alignment between the motor and shaft load. Failure to provide a proper mounting surface may cause vibration, misalignment and bearing damage. For mounting dimensions, refer to http://www.baldor.com/products/servo_motors.asp and provide adequate clearance.

Alignment Accurate alignment of the motor with the driven equipment is extremely important.

1. **Direct Coupling**

For direct drive, use flexible couplings if possible. Consult the drive or equipment manufacturer for more information. Mechanical vibration and roughness during operation may indicate poor alignment. Use dial indicators to check alignment. The space between coupling hubs should be maintained as recommended by the coupling manufacturer.

2. **End-Play Adjustment**

The axial position of the motor frame with respect to its load is also extremely important. The motor bearings are not designed for excessive external axial thrust loads. Improper adjustment will cause failure.

Figure 2-1 Mounting Orientation

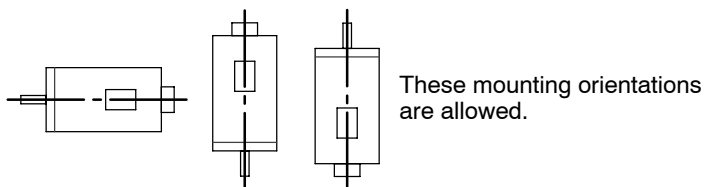

Receiving Each Baldor Electric Motor is thoroughly tested at the factory and carefully packaged for shipment. When you receive your motor, there are several things you should do immediately.

1. Observe the condition of the shipping container and report any damage immediately to the commercial carrier that delivered your motor.
2. Verify that the part number of the motor you received is the same as the part number listed on your purchase order.

Storage If the motor is not put into service immediately, the motor must be stored in a clean, dry and warm location. If the parts are not put into service immediately, store them in a clean, dry and warm location. The motor must be protected from moisture and condensation. Storage area should be a dust free environment, maintained -25 degC to $+85$ degC and less than 90% relative humidity non-condensing.

Unpacking Each Baldor motor is packaged for ease of handling and to prevent entry of contaminants.

1. To avoid condensation inside the motor, do not unpack until the motor has reached room temperature. (Room temperature is the temperature of the room in which it will be installed). The packing provides insulation from temperature changes during transportation.
2. When the motor has reached room temperature, remove all protective wrapping material from the motor.

Handling Use proper care and procedures that are safe during handling, lifting, installing, operating and maintenance operations. Improper methods may cause muscle strain or other harm.

Repairs Baldor will not share any responsibility for damage caused by customer attempt to repair or modify a motor. Consult Baldor for any service.

Prevent Electrical Noise

Electro-Magnetic-Interference (EMI), commonly called “electrical noise” may adversely affect motor performance by introducing stray signals. Effective techniques to reduce or prevent EMI include AC power filters, cable shielding, separating signal wires from power wires and good grounding techniques. Effective AC power filtering can be achieved by using properly installed “Isolated AC Power Transformers” or “AC Line Filters”. Other techniques are:

- Install motor cables and signal wires in separate conduits.
- Do not route motor cables and signal wires in parallel. Separate cables by at least 1 foot for every 30 feet of run.
- Cross signal and power wires at 90 degree angles to prevent inductive noise coupling.
- Do not route signal wires over the vent openings of the servo drives.
- Ground all equipment using a single point ground system.
- Keep wires as short as possible.
- Ground both ends of the encoder cable and use twisted pair wires.
- Use shielded motor cables to prevent EMI from other equipment.

Shaft Loads The motors can be damaged by excessive shaft loads. This may shorten the motor's service life. The motor warranty is also voided for excessive shaft load related failures.

The maximum allowable radial force ($F_{radial\ max}$) depends on the shaft load. It is determined by (distance x force) and the output shaft design (plain shaft or shaft with keyway). When motor shaft has both a radial load and an axial load, axial load rating = 44% of radial load rating listed. Should questions arise contact Motion_Support@Baldor.com

Figure 2-2 Radial Load Capacity

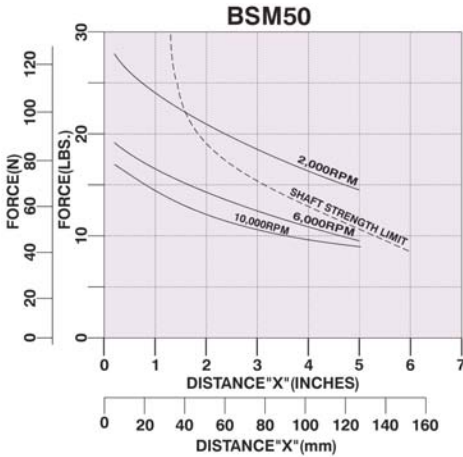

Notes:

- 1) Solid lines are based on $L_{10} = 20,000$ hours.
- 2) Dashed line is based on 10^4 load peaks @ 110% of rated torque.

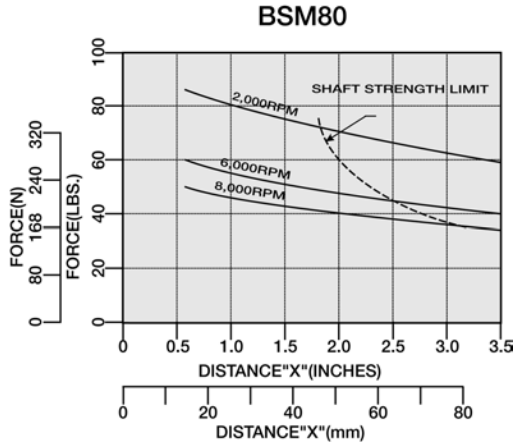
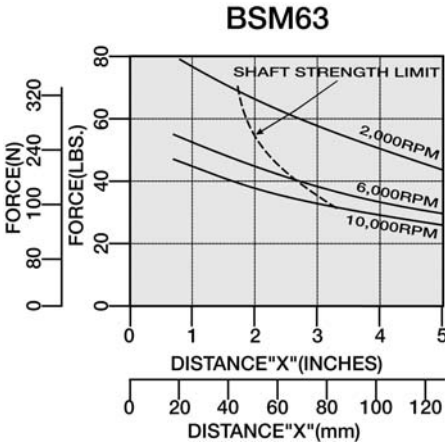
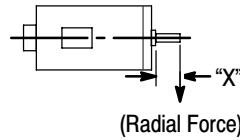
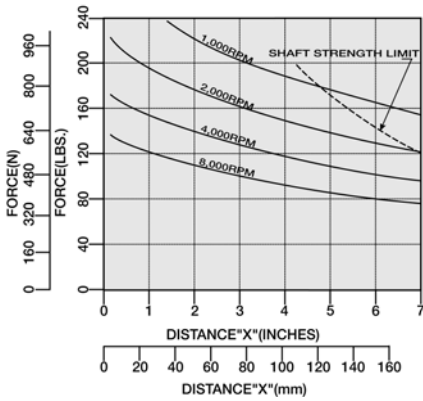
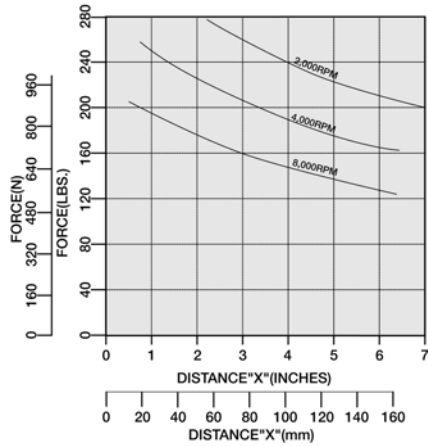

Figure 2-2 Radial Load Capacity Continued

BSM90



BSM100



**BRUSHLESS SERVO MOTORS
THRUST LOAD CAPACITIES**

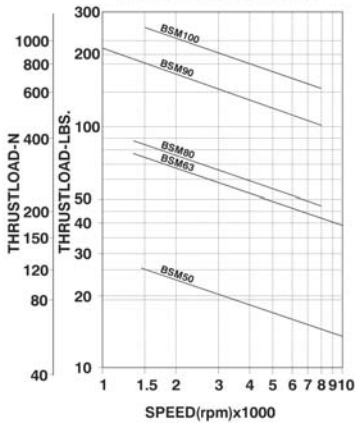

Life Determination

How Life is Determined

A life estimate is a calculated, statistical expectancy and is defined as the length of time, or the number of revolutions, until fatigue develops. This life depends on many different factors such as loading, speed, lubrication, operating temperature, contamination, plus other environmental factors. It's impossible to predict precisely.

Statistical calculation estimates are based upon L_{10} life. This is the life that 90 percent of a group, of apparently identical parts, will reach or exceed. Typical bearing radial load capacity curves presented in the literature are based upon bearing L_{10} life of 20,000 hours.

Using the Curves

First determine your load (or force), location (or distance) from the bearing the load will be applied, and speed (or RPM). Typical bearing radial load capacity curves presented in the literature are based upon bearing L_{10} life of 20,000 hours for a BSM80 Motor, (Figure 2-3). Second, plot these points on the curve. For example, a force of 80 lbs (352 N), applied 1 inch (25mm) from the bearing, with a motor speed of 2,000 RPM, would relate to a bearing L_{10} life estimate of 20,000 hours.

Figure 2-3

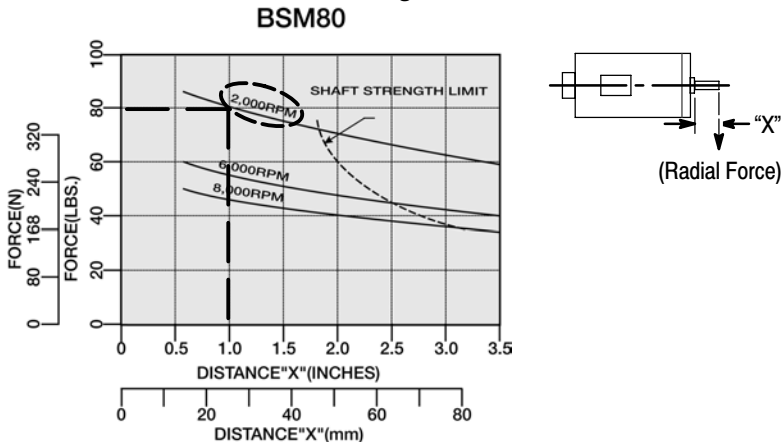

Operating 24 hours / day, which is 8500 hours, this would provide a L_{10} life estimate of: (20,000 hours) (8500 hours/yr)=2.35yrs.

If Plotted Point Does Not Match your RPM

Many times the point plotted (force and distance), is not specifically on your applications speed curve, so an estimate for life is calculated as follows:

$$L_{10} = \left(\frac{16667}{S} \right) \times \left(\frac{C}{F} \right)^3$$

Where: L_{10} = 20,000 hours
 S = RPM
 C = capacity of system
 F = Force or Load (lb)

Example: Provide an estimate L_{10} life for a BSM90 motor with a radial load or force of 130 lbs (570 N) located 3" (76mm) from the bearing. Operating speed is 1000 RPM.

1. Determine the systems capacity – at the distance for our application. To do this, refer to Figure 2-4 and read information from the curve:
 - a. Locate our distance (3") on the X axis.
 - b. Pick a speed (8,000 RPM) and locate the intersect with the 3".
 - c. Read the force (100 lbs) on the Y axis.

Figure 2-4 BSM90 Load Capacity Curves
BSM90

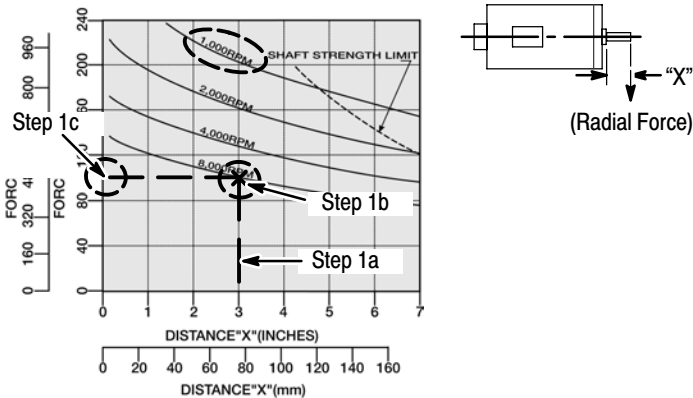

- d. Next, insert these numbers into equation (1) above and solve for capacity "C" (round off for clarity):

$$L_{10} = \left(\frac{16667}{S} \right) \times \left(\frac{C}{F} \right)^3 = \left(\frac{16 \times 10^3}{8 \times 10^3} \right) \times \left(\frac{C}{100} \right)^3$$

$$20,000 = \left(\frac{16667}{8000} \right) \times \left(\frac{C}{100} \right)^3$$

$$C = 2125$$

2. Now that capacity is known, it is possible to estimate L_{10} with the applications load of 130 lbs (570 N) and 1000 RPM.

$$L_{10} = \left(\frac{16667}{S} \right) \times \left(\frac{C}{F} \right)^3 = \left(\frac{16 \times 10^3}{1 \times 10^3} \right) \times \left(\frac{2125}{130} \right)^3 = 72,795 \text{ hours}$$

This relates to 72,795 hours / 8500 hours/yr = 8.56 years.

Conclusion

Life is a statistical calculation based upon 90 percent of identical parts reaching or exceeding an estimate. It depends on many different factors and is impossible to predict precisely, however calculations provide a guideline.

Motor Poles

BSM50/63/80 Series motors are 4 pole (2 pole pair)

BSM90/100 Series motors are 8 pole (4 pole pair)

Speed and Torque

The speed–torque curves for a motor show the safe operating area, speed limit area and intermittent operating area. These curves are used to determine the maximum useable speeds with known torque requirements. If operating within the continuous area, the motor’s thermal limit will not be exceeded. If operated within the intermittent area (extended operation in this area will cause the motor to overheat), the operating time in this area must be limited to prevent overheating.

Brushless servo motors are rated at an ambient of 25 degrees C and a temperature rise of 130 degrees C. For operation at 40 degrees C derate by 6%.

WARNING: Severe burn is possible. The motor winding can reach 155 degrees C during operation. Do not touch motor without protective clothing or allow sufficient time for motor to cool to avoid burns.

Figure 2-5 Typical Speed–Torque Curve

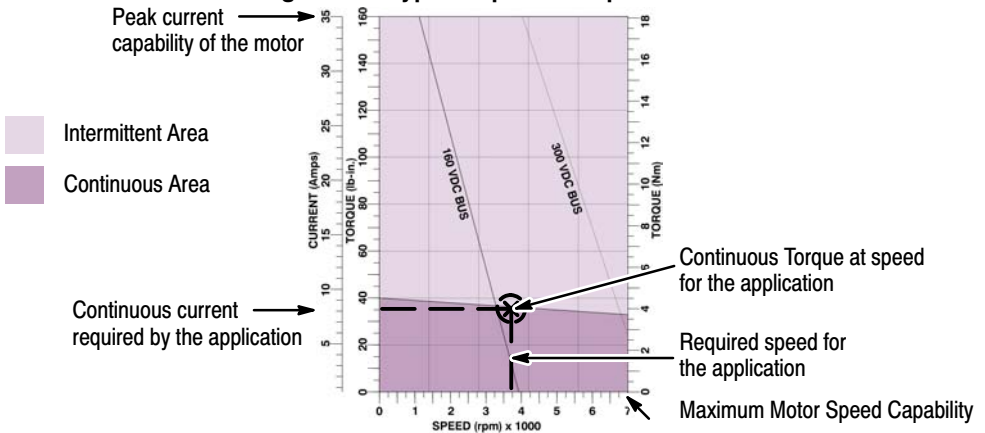

Holding Brake

Holding brakes are offered as options for servo motors. These brakes are designed to hold the motor shaft at 0 RPM (to rated brake holding torque). The purpose of the holding brake is to hold the servo axis when power to the machine is turned off. The holding brake uses the “electric release” principle. Apply 24VDC to the brake causes the brake to release and let the motor shaft rotate. Loss of power causes the brake to hold the motor shaft. The machine controller controls the holding brake. This ensures correct On and Off switching sequence.

WARNING: The holding brake alone does not guarantee personnel safety. Use structural measures such as protective fences or a second brake to secure personnel safety.

Caution: Do not use the holding brake to stop motion. This will cause premature brake wear and failure. The brakes are not designed to stop a rotating load. The servo drive inputs should always be used to stop motor shaft rotation.

Table 2-1 Brake Specifications

Motor Code	Brake Holding Torque (lb-in / N-m)	Watts	Brake Voltage VDC	Brake Current AMPS	Brake Times (msec)	
					Pull-in	Pull-out (with Diode)
BSM50N-1	13/1.4	10.1	24	0.5	18.6	55
BSM50N-2	13/1.4	10.1	24	0.5	18.6	55
BSM50N-3	13/1.4	10.1	24	0.5	18.6	55
BSM63N-1	18/2	11.9	24	0.6	33.5	33.8
BSM63N-2	18/2	11.9	24	0.6	33.5	33.8
BSM63N-3	18/2	11.9	24	0.6	33.5	33.8
BSM80N-1	40/4.5	19.7	24	0.7	34.5	79.3
BSM80N-2	40/4.5	19.7	24	0.7	34.5	79.3
BSM80N-3	40/4.5	19.7	24	0.7	34.5	79.3
BSM90N-1	77/8.7	22.5	24	0.9	64.1	73.6
BSM90N-2	140/15.8	22.5	24	0.9	64.1	73.6
BSM90N-3	140/15.8	22.5	24	0.9	64.1	73.6
BSM100N-1	200/22.5	31.4	24	1.3	83.9	188
BSM100N-2	200/22.5	31.4	24	1.3	83.9	188
BSM100N-3	350/39.5	33.7	24	1.4	157.3	220
BSM100N-4	350/39.5	33.7	24	1.4	157.3	220
BSM80C-1	30/3.3	19.7	24	0.8	34.5	79.3
BSM80C-2	30/3.3	19.7	24	0.8	34.5	79.3
BSM80C-3	30/3.3	19.7	24	0.8	34.5	79.3
BSM90C-1	77/8.7	22.5	24	0.9	64.1	73.6
BSM90C-2	77/8.7	22.5	24	0.9	64.1	73.6
BSM90C-3	77/8.7	22.5	24	0.9	64.1	73.6
BSM100C-1	200/22.5	31.4	24	1.3	83.9	188
BSM100C-2	200/22.5	31.4	24	1.3	83.9	188
BSM100C-3	200/22.5	31.4	24	1.3	83.9	188
BSM100C-4	200/22.5	31.4	24	1.3	83.9	188
BSM100C-5	350/39.5	33.7	24	1.4	157.3	220
BSM100C-6	350/39.5	33.7	24	1.4	157.3	220

Electrical Connections

Overview Figure 2-6 shows typical connections to a control. Note all wiring should be 600volts.

Figure 2-6 Typical Connections to Motor Control

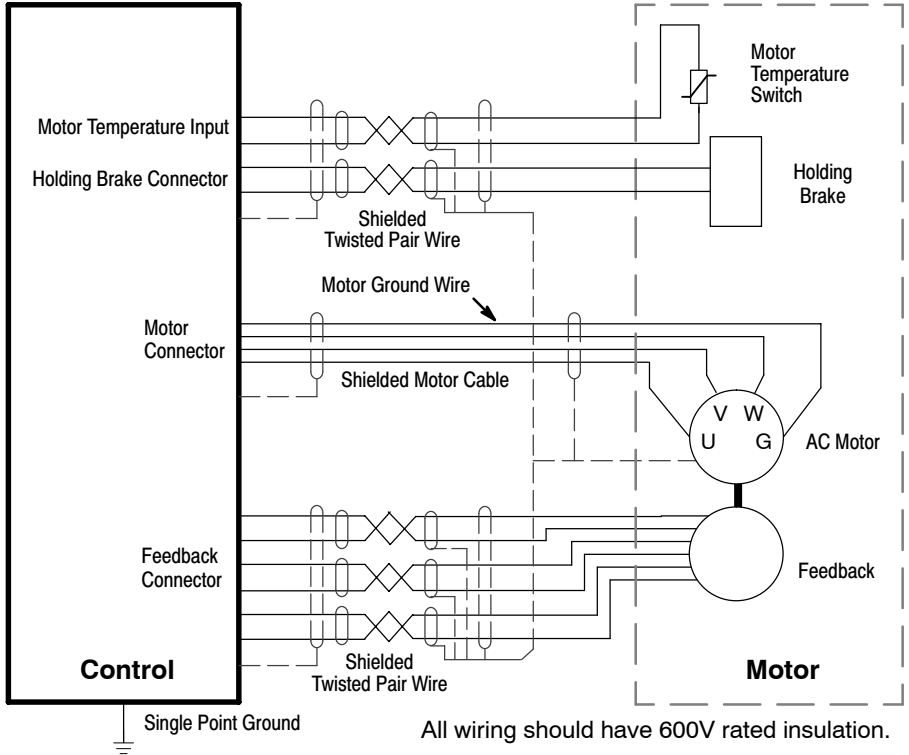

Motor Lead Termination

Motor leads are normally terminated using a Connector or Terminal Box (see Figure 2-7) or Flying Leads. When no termination is provided and the motor leads just exit the motor housing, this is called "Flying Leads". For flying leads, refer to the motor packing list to determine the lead configuration.

Figure 2-7 Motor Termination

Function	Pin
Thermal Switch	A
Thermal Switch	B
Brake	C
Brake	D
U	1
Ground	2
W	3
V	4

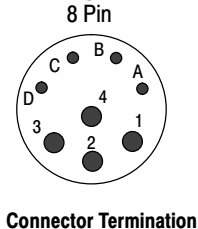

Function	Pin
Thermal Switch	1
Thermal Switch	2
Brake	3
Brake	4
U	U
V	V
W	W
Ground (P.E.)	Screw

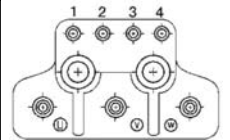

Terminal Box Termination

Strain Relief (Mounted at Terminal Box)

The motor cable is terminated at the Terminal Box using a Shielded Strain Relief Connector. Figure 2-8 shows the components.

1. Strip the outer shield from the cable to expose the conductors and shield.
2. Slip the Strain Relief components onto the cable in the order shown.
3. Fold the Shield wires over the end of the Contact Carrier.
4. Slide the Threaded Adapter onto the Contact Carrier until the Carrier is completely inserted into the Adapter.
5. Slide the Gasket into the Contact Carrier.
6. Slide the Adapter Cover onto the Threaded Adapter and Tighten. As it is tightened, it compresses the Gasket against the Cable to form the strain relief and securely hold the cable.
7. The assembly can be inserted into the Terminal Box and secured.

Figure 2-8 Motor Cable Strain Relief Assembly

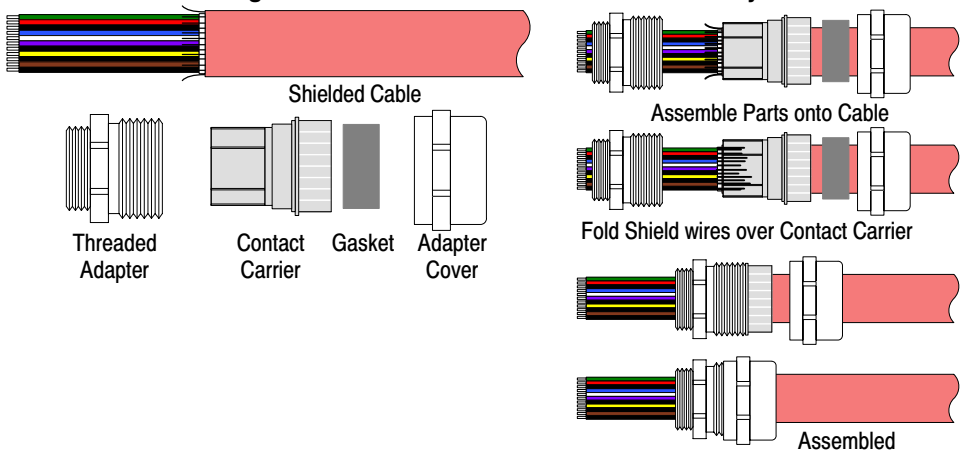

Feedback Termination

Connections for Feedback cables are different for each type of feedback device. Standard devices are: Resolver, Halls (Hall Effect), Incremental Encoder with Halls, Absolute Encoder, and SSI (Serial Synchronous Interface) encoder. Custom feedback devices are also available. Request a drawing of your feedback device to determine the pin-out and/or wire color codes.

Figure 2-9 Typical Connections to Feedback Termination

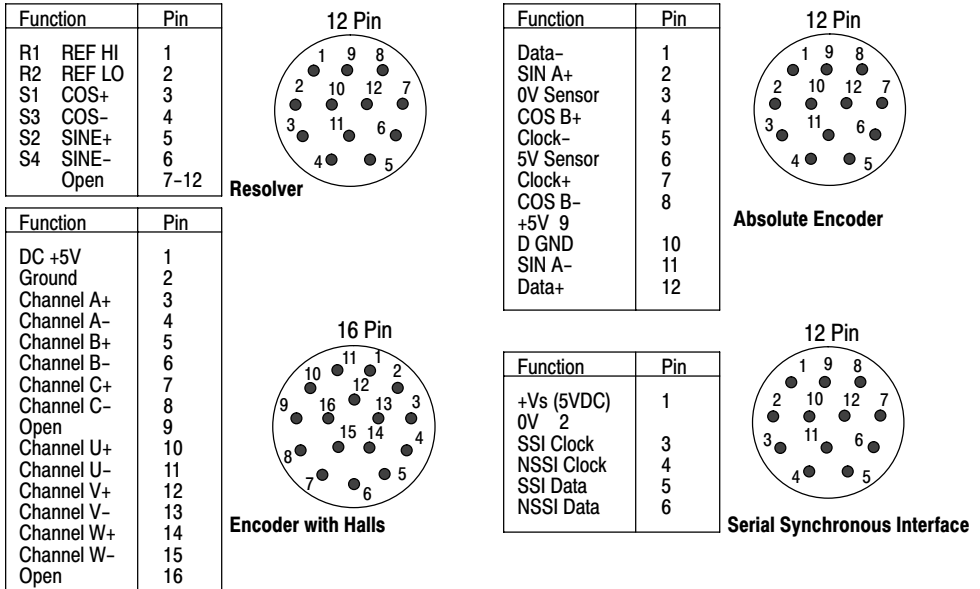

For complete control connections/wiring refer to the following manuals:
 MN723 – SD23H MN7423 – H2 Servo
 MN1902 – Flex/Flex+Drive^{II} MN1901 – MintDrive^{II}
 MN1919 – MicroFlex

Feedback Devices

Resolver

Common feedback devices for Baldor BSM servo motors include Resolver, Encoder, Absolute Encoder, and SSI (Serial Synchronous Interface) encoder. Custom feedback devices are also available. Contact Baldor for more information.

Figure 2-10 Typical Resolver Feedback Device

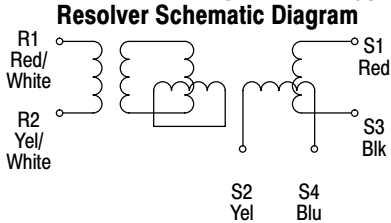

Resolver Specification

Power Source	AC 10V _{RMS} 4.5kHz
Primary Element	Rotor
Electrical Error	±7%
Transformation Ratio	0.5 ±10%
Phase Shift	±8° nominal
Accuracy Spread	12 ARC minutes
Input Impedance	ZRO
Output Impedance	ZSO
DC Resistance	ZSS
	Rotor
	Stator
Dielectric Strength	AC 500 volts, 1 minute 60/50 Hz
Insulation Resistance	100MΩ Minimum DC 500Volts
Weight	0.18kg Maximum
Maximum Operating Speed	10,000 RPM
Operating Temperature Range	-55 °C to +150 °C

L2=Motor lead L2 (V)
L3=Motor lead L3 (W)

Waveform 1 8 Pole Motor and 2 Pole Resolver

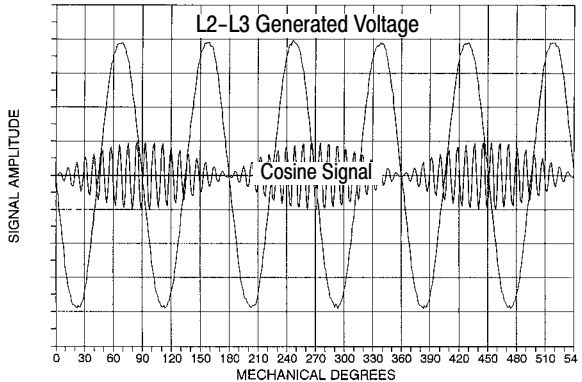

Waveform 2 4 Pole Motor and 2 Pole Resolver

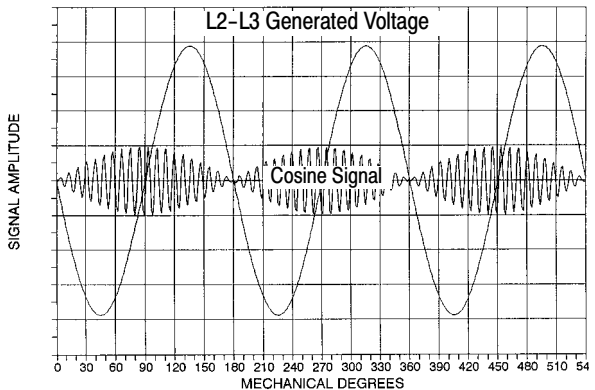

Feedback Devices Continued

Encoder

Line Count Depends on unit ordered. Standards are 1000–2500 ppr.
(Custom resolutions are available.)

Supply Voltage 5VDC

Supply Current 250mA maximum

Output TTL (Line Driver)

Figure 2-11 Typical Encoder Feedback Device

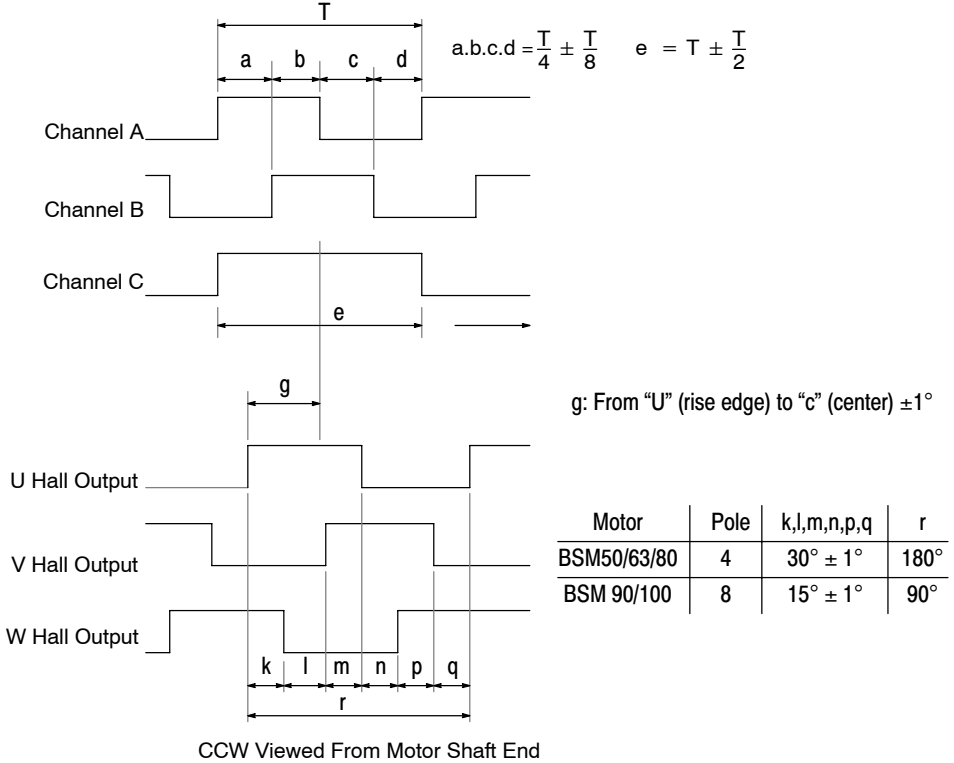

Brushless Servo Motor Identification

□	□	B	S	M	□	□	□	□	□	□	□	□	□	□	□	□	□	□	□	
		Frame				Series					Winding Code									
SS = Stainless Steel		IEC	NEMA		C						50									
		50	5N		N						75									
		63	6N								etc.									
		80	8N																	
		90	9N																	
		100																		
		Motor Options																		

Feedback Options

- A = Resolver
- D = Absolute Encoder
- E = Encoder w/Commutation (1000ppr)
- F = Encoder w/Commutation (2500ppr)
- H = Hall effect only
- T = Tach/Hall effect
- Y = Resolver mounting only

Accessory Options

- Blank = No Option
- M = No Keyway
- N = DIN 42955-R
- O = DIN 42955-R & No Keyway
- P = Optional Motor Connector on BSM 90/100
(Note: This option available only if current is 20 amps or less).
- Z = Blower 115 VAC

- Notes:
- 1) The standard BSM50/63/80 Series includes feedback device, two threaded connectors (metric style) for feedback and motor terminations, IEC square mounting flange.
 - 2) The standard BSM90/100 Series includes feedback device, one threaded connector (metric style) for feedback, termination of motor lead wires on terminal block, IEC square mounting flange.
 - 3) Motors do not have shaft seal. Motors will meet IP65 if shaft oil seal is added.
 - 4) The standard BSM50 Series has as standard no-keyway.
 - 5) Cables and flying leads are 1 meter long as standard.
 - 6) Contact Baldor for special options
 - 7) Not all options are available on all models.

Baldor District Offices

UNITED STATES

ARIZONA
PHOENIX
4211 S 43RD PLACE
PHOENIX, AZ 85040
PHONE: 602-470-0407
FAX: 602-470-0464

ARKANSAS
CLARKSVILLE
1001 COLLEGE AVE.
CLARKSVILLE, AR 72830
PHONE: 479-754-9108
FAX: 479-754-9205

CALIFORNIA
LOS ANGELES
6480 FLOTILLA
COMMERCE, CA 90040
PHONE: 323-724-6771
FAX: 323-721-5899

HAYWARD
21056 FORBES STREET
HAYWARD, CA 94545
PHONE: 510-785-9900
FAX: 510-785-9910

COLORADO
DENVER
2520 W BARBERRY PLACE
DENVER, CO 80204
PHONE: 303-623-0127
FAX: 303-595-3772

CONNECTICUT
WALLINGFORD
65 SOUTH TURNPIKE ROAD
WALLINGFORD, CT 06492
PHONE: 203-269-1354
FAX: 203-269-5485

FLORIDA
TAMPA/PUERTO RICO/
VIRGIN ISLANDS
3908 EAST 11TH AVENUE
TAMPA, FL 33605
PHONE: 813-249-5078
FAX: 813-247-2984

GEORGIA
ATLANTA
82 TECHNOLOGY DR.
ALPHARETTA, GA 30005
PHONE: 770-772-7000
FAX: 770-772-7200

ILLINOIS
CHICAGO
1601 FRONTENAC ROAD
NAPERVILLE, IL 60563
PHONE: 630-848-5100
FAX: 630-848-5110

INDIANA
INDIANAPOLIS
5525 W MINNESOTA STREET
INDIANAPOLIS, IN 46241
PHONE: 317-246-5100
FAX: 317-246-5110
800-428-4141

IOWA
DES MOINES
1800 DIXON STREET, SUITE C
DES MOINES, IA 50316
PHONE: 515-263-6929
FAX: 515-263-6915

MARYLAND
BALTIMORE
6880 SANTA BARBARA RD.
SUITE 22-24
ELKPRIDGE, MD 21075
PHONE: 410-579-2135
FAX: 410-579-2677

MASSACHUSETTS
BOSTON
6 PULLMAN STREET
WORCESTER, MA 01606
PHONE: 508-854-0708
FAX: 508-854-0291

MICHIGAN
DETROIT
33782 STERLING PONDS BLVD
STERLING HEIGHTS, MI 48312
PHONE: 586-978-9800
FAX: 586-978-9969

GRAND RAPIDS
688 3 MILE ROAD NW
GRAND RAPIDS, MI 49504
PHONE: 616-785-1784
FAX: 616-785-1788

MINNESOTA
MINNEAPOLIS
21080 134TH AVE. NORTH
ROGERS, MN 56374
PHONE: 763-428-3633
FAX: 763-428-4551

MISSOURI
ST LOUIS
422 INDUSTRIAL DRIVE
MARYLAND HEIGHTS, MO 63043
PHONE: 314-298-1800
FAX: 314-298-7680

KANSAS CITY
1501 BEDFORD AVENUE
NORTH KANSAS CITY, MO 64116
PHONE: 816-587-0272
FAX: 816-587-3735

NEW YORK
ALBURN
ONE ELLIS DRIVE
ALBURN, NY 13021
PHONE: 315-255-3403
FAX: 315-253-9923

NORTH CAROLINA
GREENSBORO
1220 ROTHERWOOD ROAD
GREENSBORO, NC 27406
P O BOX 16500
GREENSBORO, NC 27416
PHONE: 336-272-6104
FAX: 336-273-6628

OHIO
CINCINNATI
2628 CRESCENTVILLE ROAD
WEST CHESTER, OH 45069
PHONE: 513-771-2600
FAX: 513-772-2219

CLEVELAND
8929 FREEMAY DRIVE
MACEDONIA, OH 44056
PHONE: 330-468-4777
FAX: 330-468-4778

OKLAHOMA
TULSA
2 EAST DAVES
BIXBY, OK 74008
PHONE: 918-366-9320
FAX: 918-366-9338

OREGON
PORTLAND
20353 SW AVERY COURT
TUALATIN, OR 97062
PHONE: 503-691-9010
FAX: 503-691-9012

PENNSYLVANIA
PHILADELPHIA
1035 THOMAS BUSCH
MEMORIAL HIGHWAY
PENSACOLA, NJ 08110
PHONE: 856-661-1442
FAX: 856-663-6363

PITTSBURGH
6166 BERRY ROAD
MONROEVILLE, PA 15146
PHONE: 412-380-7244
FAX: 412-380-7250

TENNESSEE
MEMPHIS
4000 WINCHESTER ROAD
MEMPHIS, TN 38118
PHONE: 901-365-2020
FAX: 901-365-3914

TEXAS
HOUSTON
4647 PINE TIMBERS
SUITE 1135
HOUSTON, TX 77041
PHONE: 713-895-7062
FAX: 713-690-4540

DALLAS
3040 QUEBEC
DALLAS, TX 75247
PHONE: 214-634-7271
FAX: 214-634-8874

UTAH
SALT LAKE CITY
2230 SOUTH MAIN STREET
SALT LAKE CITY, UT 84115
PHONE: 801-832-0127
FAX: 801-832-8911

WISCONSIN
MILWAUKEE
2725 SOUTH 163RD STREET
NEWBERLIN, WI 53151
PHONE: 262-784-5940
FAX: 262-784-1215

INTERNATIONAL SALES

FORT SMITH, AR
P.O. BOX 2400
FORT SMITH, AR 72902
PHONE: 479-646-4711
FAX: 479-648-5895

CANADA
EDMONTON, ALBERTA
4053-92 STREET
EDMONTON, ALBERTA T6E 6R8
PHONE: 780-434-4500
FAX: 780-438-2600

OAKVILLE, ONTARIO
2750 COVENTRY ROAD
OAKVILLE, ONTARIO L6H 6R1
PHONE: 905-829-3301
FAX: 905-829-3302

MONTREAL, QUEBEC
1844 WILLIAM STREET
MONTREAL, QUEBEC H3J 1R5
PHONE: 514-933-2711
FAX: 514-933-8639

VANCOUVER, BRITISH COLUMBIA
1538 KEBET WAY
PORT COQUITLAM, BC V3C 5M5
PHONE: 604-421-2822
FAX: 604-421-3113

WINNIPEG, MANITOBA
54 PRINCESS STREET
WINNIPEG, MANITOBA R3B 1K2
PHONE: 204-942-5205
FAX: 204-956-4251

AUSTRALIA
UNIT 3, 6 STANTON ROAD
SEVEN HILLS, NSW 2147,
AUSTRALIA
PHONE: (61) (2) 9674 5455
FAX: (61) (2) 9674 2495

UNIT 8, 5 KELLETTS ROAD
ROWWILLE, VICTORIA, 3178
AUSTRALIA
PHONE: (61) (3) 9753 4355
FAX: (61) (3) 9753 4366

AMERICA DEL SUR
APTDO. 9109 0818 ZONA 6
BETHANIA
CIUDAD DE PANAMÁ, PANAMÁ
PHONE: +507 261-5347
FAX: +507 261-5355

CENTRO AMÉRICA Y CARIBE
RESIDENCIAL PINARES DE SUIZA
POL. 15 #44,
NVA. SAN SALVADOR, EL SALVADOR
PHONE: +503 2288-1519
FAX: +503 2288-1518

CHINA
SHANGHAI JIA-HUA BUSINESS CENTER
ROOM NO. A-8421
808 HONG QIAO ROAD
SHANGHAI 200003
PHONE: 86-21-64473600
FAX: 86-21-64078620

GERMANY
DIESELSTRASSE 22
D-85551 KIRCHHEIM
MUNICH, GERMANY
PHONE: (49) (89) 90508 0
FAX: (49) (89) 90508 492

INDIA
14, COMMERCIAL AVENUE
MAHAGANESH COLONY
PAUD ROAD
PUNE - 411 038
MAHARASHTRA, INDIA
PHONE: 91 20 25 45 95 30
FAX: 91 20 5 4 95 30

ITALY
BALDOR ASR AG
SUCCURSIALE DI MENDRISIO
VIA BORROMINI, 20A
CH-6850 MENDRISIO
SWITZERLAND
PHONE: 41 91 640 9950
FAX: 41 91 630 2633

JAPAN
DIA BLDG 802,
2-21-1 TSURUYA-CHO,
KANAGAWA-KU
YOKOHAMA, 221-0835, JAPAN
PHONE: 81-45-412-4506
FAX: 81-45-412-4507

KOREA
ROOM 208-37
INCHON INDUSTRIAL GOODS
CIRCULATING CENTER
SONGHYEON 3-DONG, DONG-GU
INCHON, KOREA, 401-705
PHONE: 82 32 588 3253
FAX: 82 32 588 3254

MEXICO
KM. 2.0 BLVD. AL AEROPUERTO
LEON 3745, GUANAJUATO,
MEXICO
PHONE: 52 477 761 2030
FAX: 52 477 761 2010

MIDDLE EAST & NORTH AFRICA
VEE INTERNATIONAL CORP
3233 NORTH ARLINGTON HEIGHTS
SUITE 100W
ARLINGTON HEIGHTS, IL 60004
PHONE: 847 590 5547

SINGAPORE
51 KAM BUKIT ROAD 2
K B WAREHOUSE COMPLEX
SINGAPORE 417863
PHONE: (65) 6 744 2572
FAX: (65) 6 747 1708

SWITZERLAND
POSTFACH 73
SCHUTZENSTRASSE 59
CH-8245 FEUERTHALEN
SWITZERLAND
PHONE: (41) (52) 6474 700
FAX: (41) (52) 6592394

TAIWAN
4F, NO. 25, SEC. 1,
TUNHUA S ROAD,
TAIPEI 10657, TAIWAN, R.O.C.
PHONE: (886-2) 2577-4352
FAX: (886-2) 2577-4157

UNITED KINGDOM
6 BRISTOL DISTRIBUTION PARK
HAWKLEY DRIVE
BRISTOL BS52 2BF, U.K.
PHONE: +44 1454 859000
FAX: +44 1454 8590019



★ 1 2 4 0 - 0 6 0 6 ★

BALDOR®

**BALDOR ELECTRIC COMPANY
5711 R.S. Boreham Jr. Street
Fort Smith, AR 72901-2400
(479) 646-4711
Fax (479) 648-5792**